

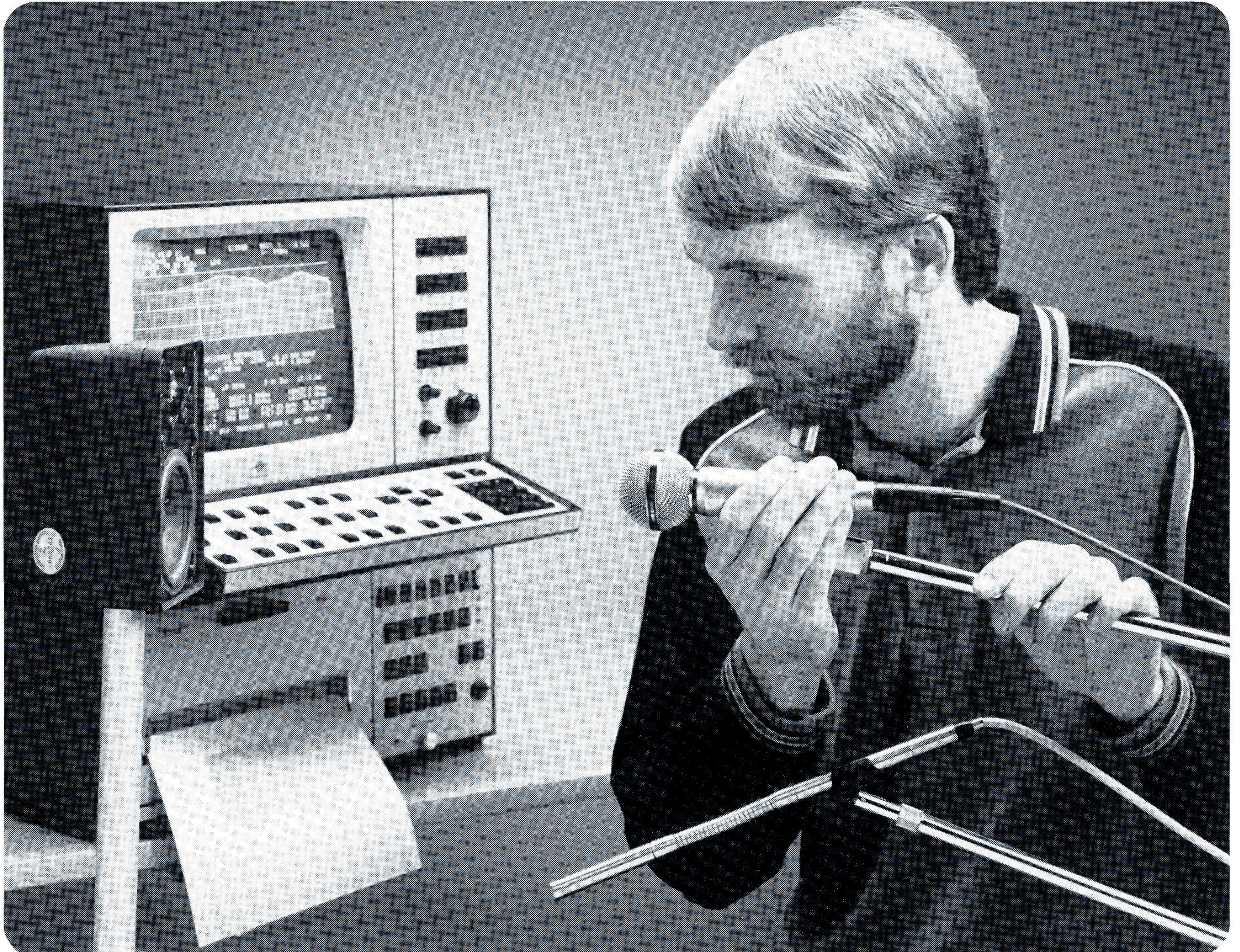

Measurement of Loudspeaker and Microphone Performance using Dual Channel FFT-Analysis

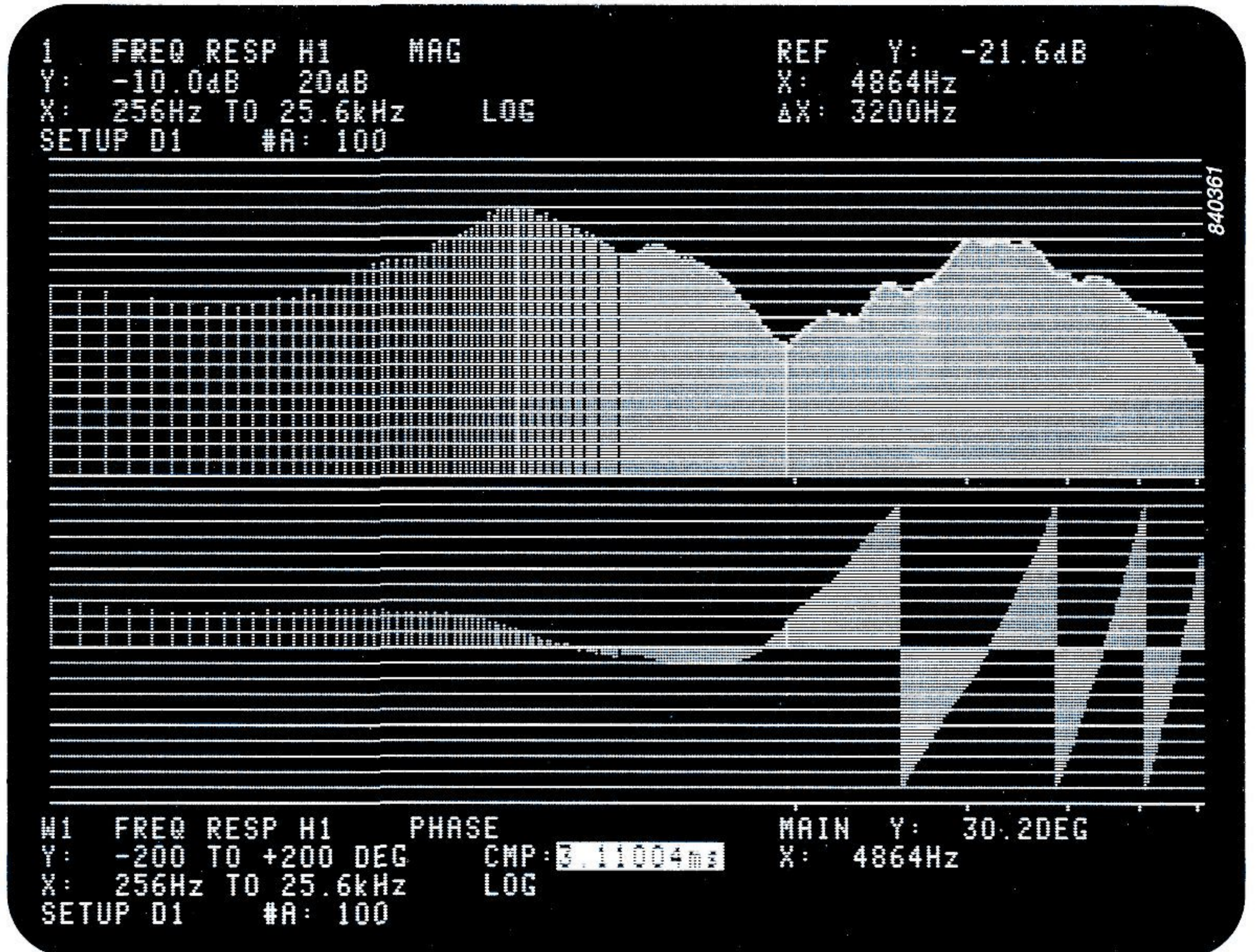

Measurement of Loudspeaker and Microphone Performance using Dual Channel FFT-Analysis

by Henrik Biering M.Sc., Brüel & Kjær

Introduction

In general, the components of an audio system have well-defined — mostly electrical — inputs and outputs. This is a great advantage when it comes to objective measurements of the performance of such devices. Loudspeakers and microphones, however, being electro-acoustic transducers, are the major exceptions to the rule and present us with two important problems to be considered before meaningful evaluation of these devices is possible.

Firstly, since measuring instruments are based on the processing of electrical signals, any measurement of acoustical performance involves the use of both a *transmitter* and a *receiver*. If we intend to measure the response of one of these, the response of the other must have a "flat" frequency response, or at least one that is known in advance.

Secondly, neither the output of a loudspeaker nor the input to a microphone are well-defined under practical circumstances where the interaction between the transducer and the room cannot be neglected if meaningful results — i.e. results correlating with subjective evaluations — are to be obtained. See Fig. 2.

For this reason a single specific measurement type for the characterization of a transducer cannot be devised. In this *Application Note* we will mainly focus on *linear response measurements* which provide important clues to the subjective performance of loudspeakers. These measurements include measurement of free-field response, directional characteristics, cabinet vibration, electrical impedance, etc. In addition, measurement of microphone characteristics, non-linear performance and more advanced measurements will also be mentioned.

Traditionally complex instrumentation has been required to carry out all of these measurements. However, with B&K Dual Channel Analyzers Types 2032 and 2034 the only extra equipment needed is a measurement micro-

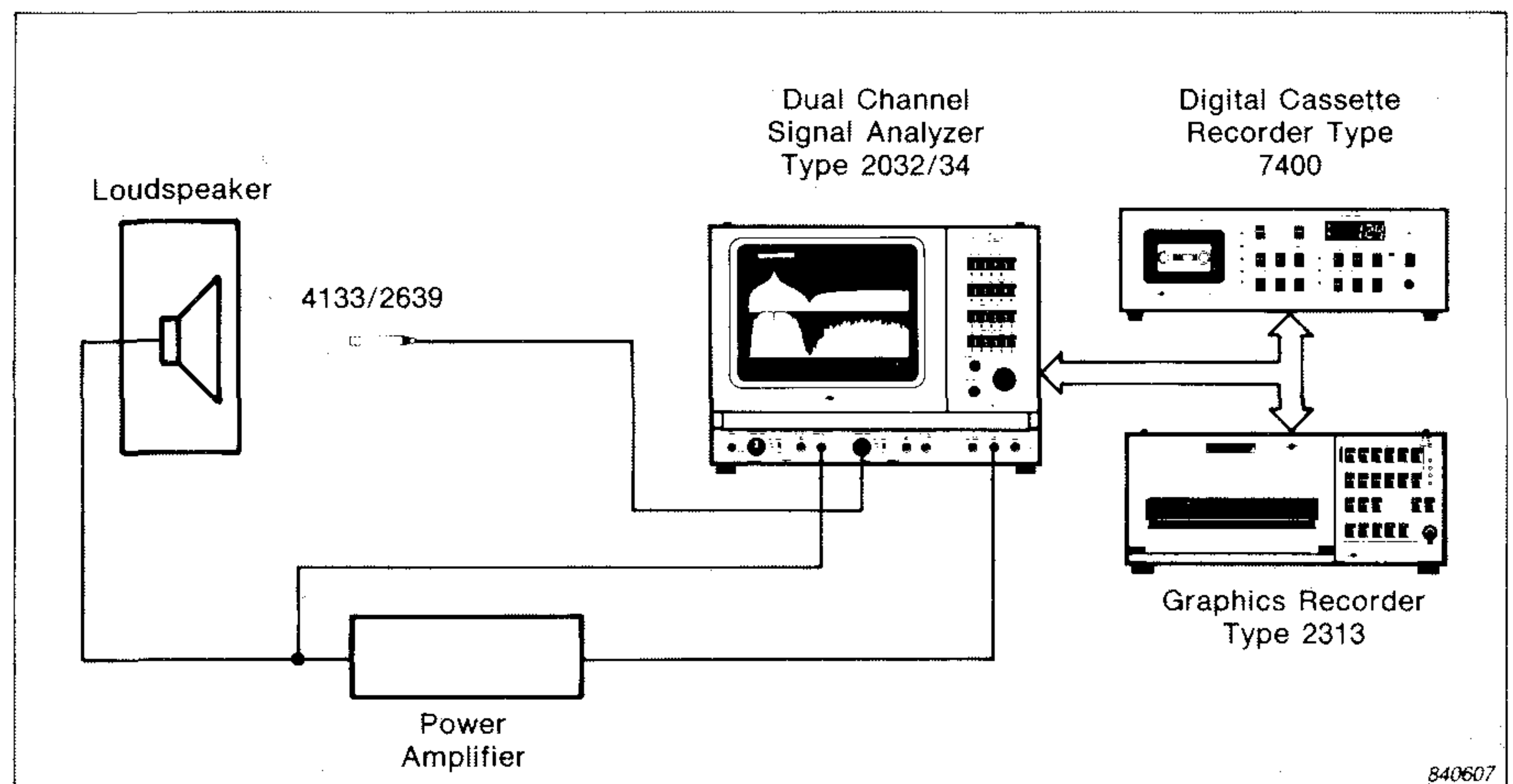

Fig. 1. General set-up for loudspeaker measurements. The Digital Cassette Recorder Type 7400 is used for storage of the measurement set-ups in addition to storage of the measured data. Graphics Recorder Type 2313 is used for reformatting data and for plotting results

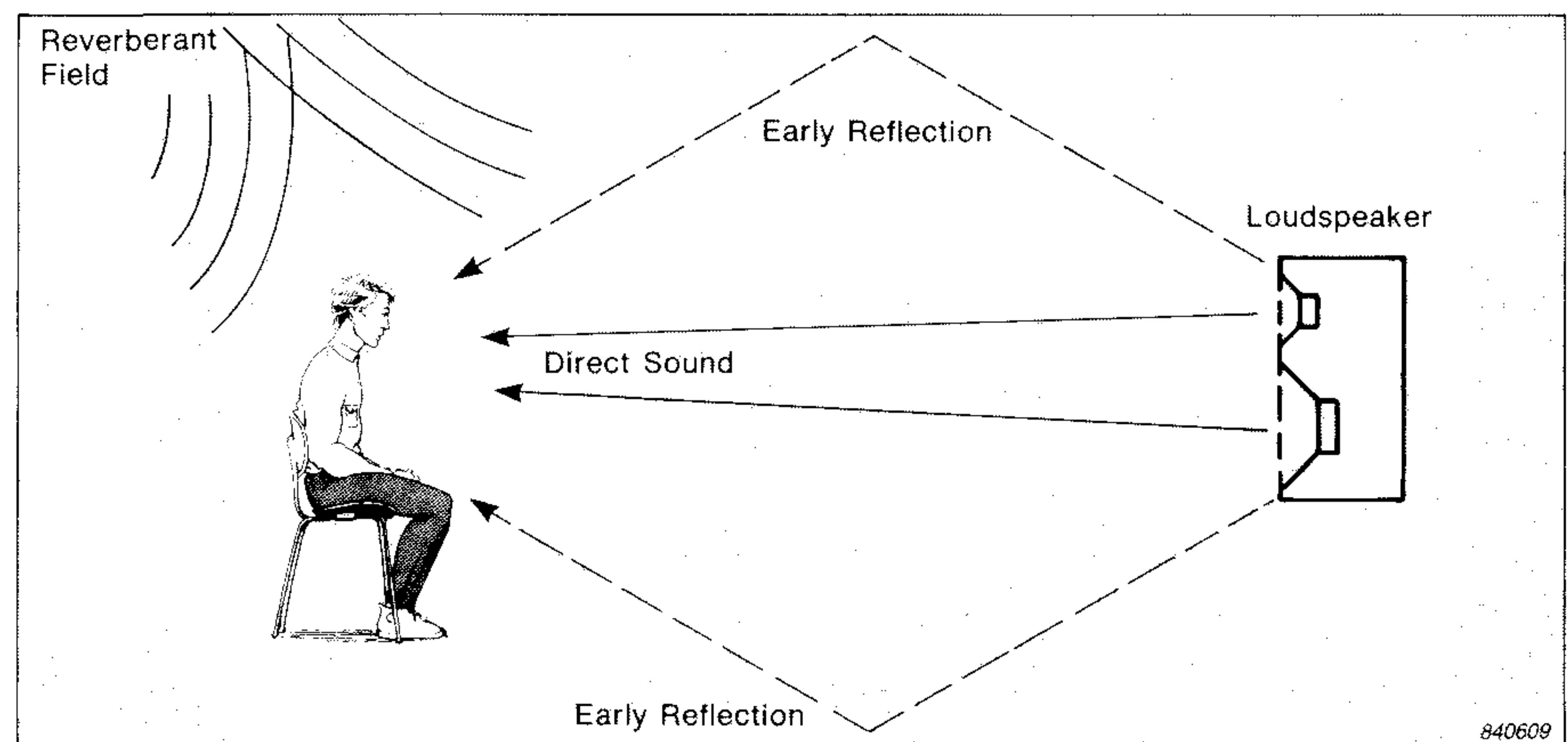

Fig. 2. In a practical listening situation, the interface between loudspeaker and listener is very complex. For convenience, contributions to the total sound field are often divided into three categories: the direct sound, the early reflections and the reverberant field

phone and an accelerometer. To enable easy change between different measurement tasks, up to ten complete measurement and display set-ups can be stored by the user for later use. Print-out of the results can be obtained using the X-Y Recorder Type 2308 or the Graphics Recorder Type 2313. The latter offers various reformatting facilities via the use of application packages. Digital Cassette Recorder Type 7400 can be used for storing measurement and display set-

ups as well as measured data on a tape cartridge. See Fig. 1.

All of the measurements described in this *Application Note* have been carried out using a small high-quality two-way loudspeaker. The measurement microphone used for the majority of the tests is B&K $\frac{1}{2}$ " free-field Type 4133 mounted on Preamplifier Type 2639. The microphone used as a test object is a low-cost general purpose microphone.

Free-field Response

Traditionally anechoic rooms have been used for measurement of the free-field response. In principle, an anechoic room attenuates all reflections before they may reach the microphone position (Fig.3). However, to attenuate reflections properly, the wedges must have a length of at least a quarter of a wavelength for all frequencies within the relevant frequency range. Thus for measurements at low frequencies a large room will be required. For accurate measurements down to 20 Hz, the inside dimensions of the room without absorbers must be of the order of 25 meters or more.^[1]

The pseudo-random signal provided by the built-in generator of Types 2032/34 has the advantage over traditional swept measurement techniques that the transducers are effectively driven by 800 sine generators in parallel. This causes a dramatic reduction in the minimum measurement time required for a test. The measurement result shown in Fig.5 was obtained within a fraction of a second.

An alternative method of measurement utilizes the finite speed of sound to isolate the direct sound from the first reflections and from the reverberant field. Due to its shorter path, the direct sound will always appear at the microphone position before the reflections. If, when using an impulse for excitation, the direct response has vanished before the first reflected signals enter the microphone, the influence of the latter can be suppressed by multiplying the signal actually recorded by a suitable "time window" (see Fig.4). The minimum width of a response peak which can be properly resolved will be inversely proportional to the maximum useful length of the time window. Since the highest measurement resolution is normally required at low frequencies (logarithmic display), this limited resolution will introduce a practical lower limit for the frequency range of a test.^[2]

Although this limitation is of a slightly different nature than the low frequency limitation for the anechoic room, the room size necessary for a given test will be approximately the same in both cases.

The impulsive nature of the test signal required for time selective measurements, however, leads to a less efficient excitation of the system un-

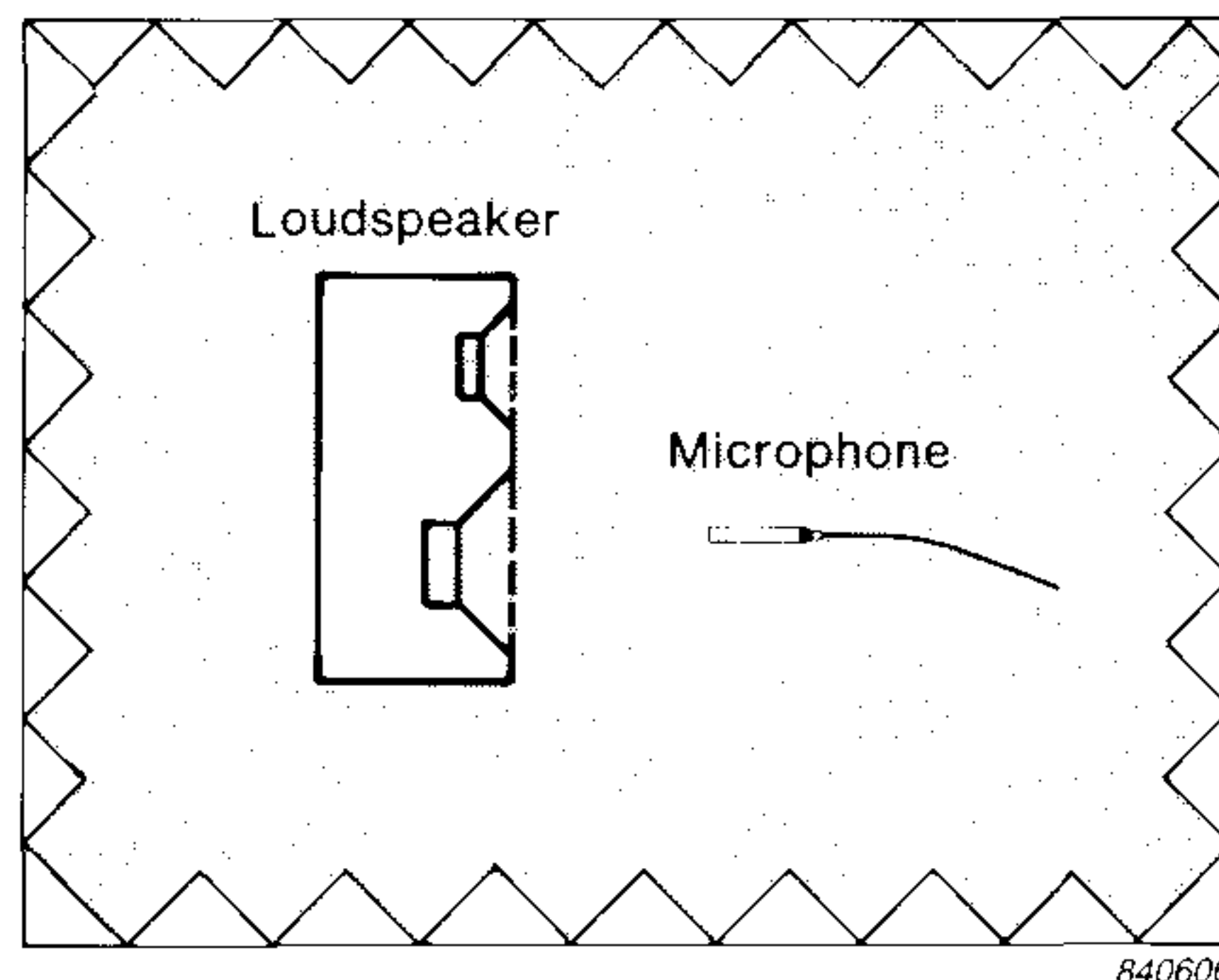

Fig.3. The on-axis free-field response is the most commonly used characteristic for the evaluation and documentation of transducer performance. Traditionally the direct sound is measured in an anechoic room, the boundaries of which absorb reflections and reverberant sound

der test and consequently to a lower signal-to-noise ratio. In the presence of background noise it will therefore be necessary to average several consecutive impulse responses. For this purpose it is generally advisable to synchronize the impulse rate with the record acquisition time of the Analyzer. Such a synchronization is automatically established when using the 2032/34 in its impulse excitation mode. For this particular application, however, a somewhat longer interval between the pulses is dictated by the reverberant environment; a new measurement should not be initiated before the reverberant field excited by the previous pulse has decayed sufficiently. Therefore a small external pulse generator has been used for the measurement displayed in Fig.7. Since the Analyzers are FFT-based in-

struments, Types 2032/34 inherently have a linear frequency axis. For improved visualization of the data, however, the 800 measured points can be displayed along a two-decade logarithmic frequency axis as shown in Fig.6. Note, however, from the response shown in Fig.7 that the phase response of a system incorporating one or more pure delays is more advantageously displayed with a linear frequency scale, where a change of slope indicates a transition between two different delays.

Until recently only little information could be derived directly from the impulse response of a system. This, however, has been a matter of poor presentation rather than lack of information. Using the Hilbert Transform, the 2032/34 can calculate the envelope or magnitude of the impulse response (see Fig.8), which displayed with a logarithmic magnitude axis reveals many otherwise hidden details related to diffraction around the loudspeaker or microphone.

Theoretically the frequency response and the impulse response present exactly the same information. Response anomalies, however, are often more naturally related to either the frequency domain (e.g. crossover networks) or the time domain (e.g. diffraction around cabinet). Provided suitable display formats are available, it is always more convenient to investigate response problems in their natural domain, as demonstrated in Figs.9 and 10.

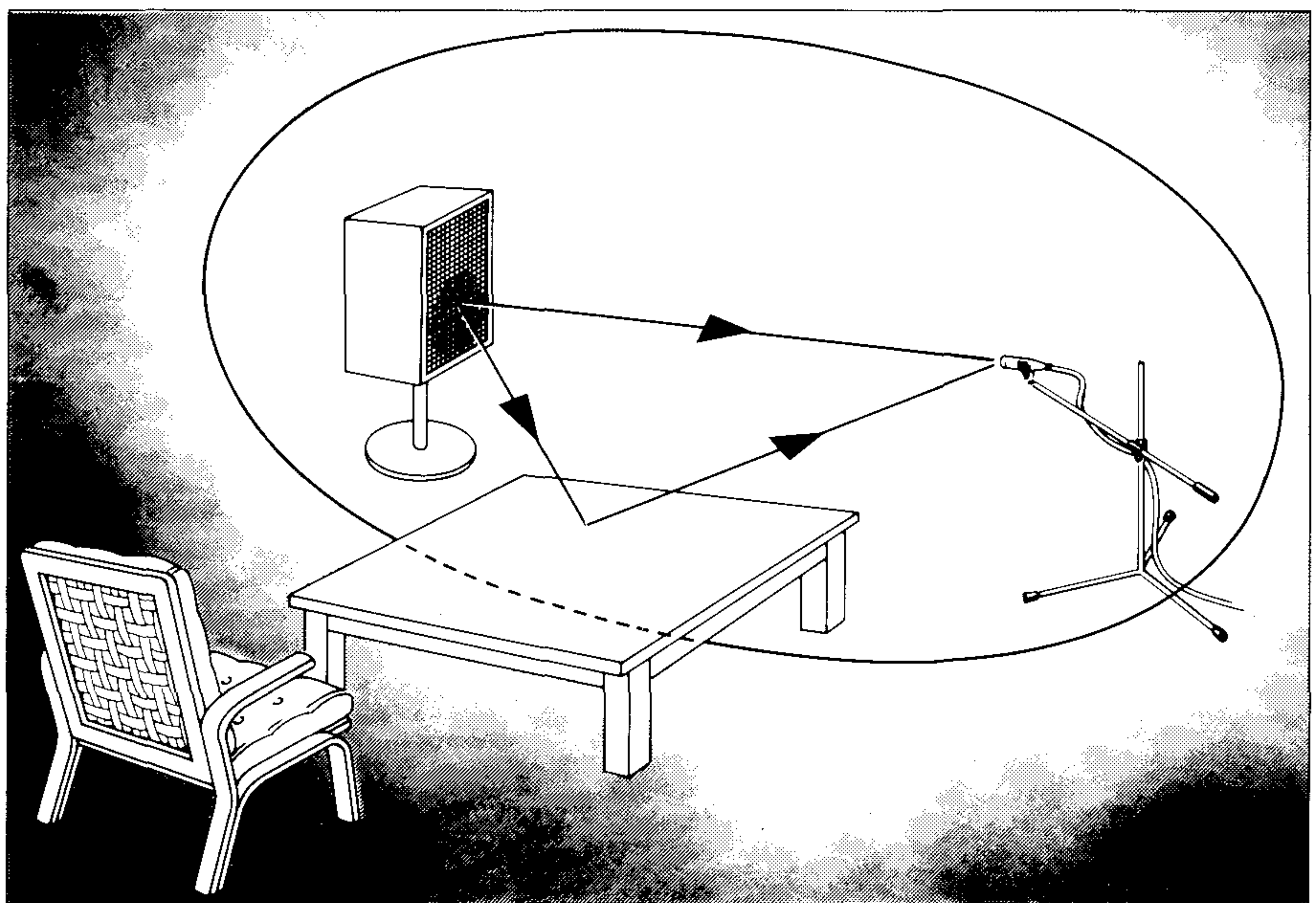

Fig.4. When the measurement technique allows the use of time gating — windowing — it is possible to isolate the direct sound from the reflections which are always present in a normal environment. Only objects which are located within an ellipsoid, the size of which depends on the length of the time window, interfere with the measurement

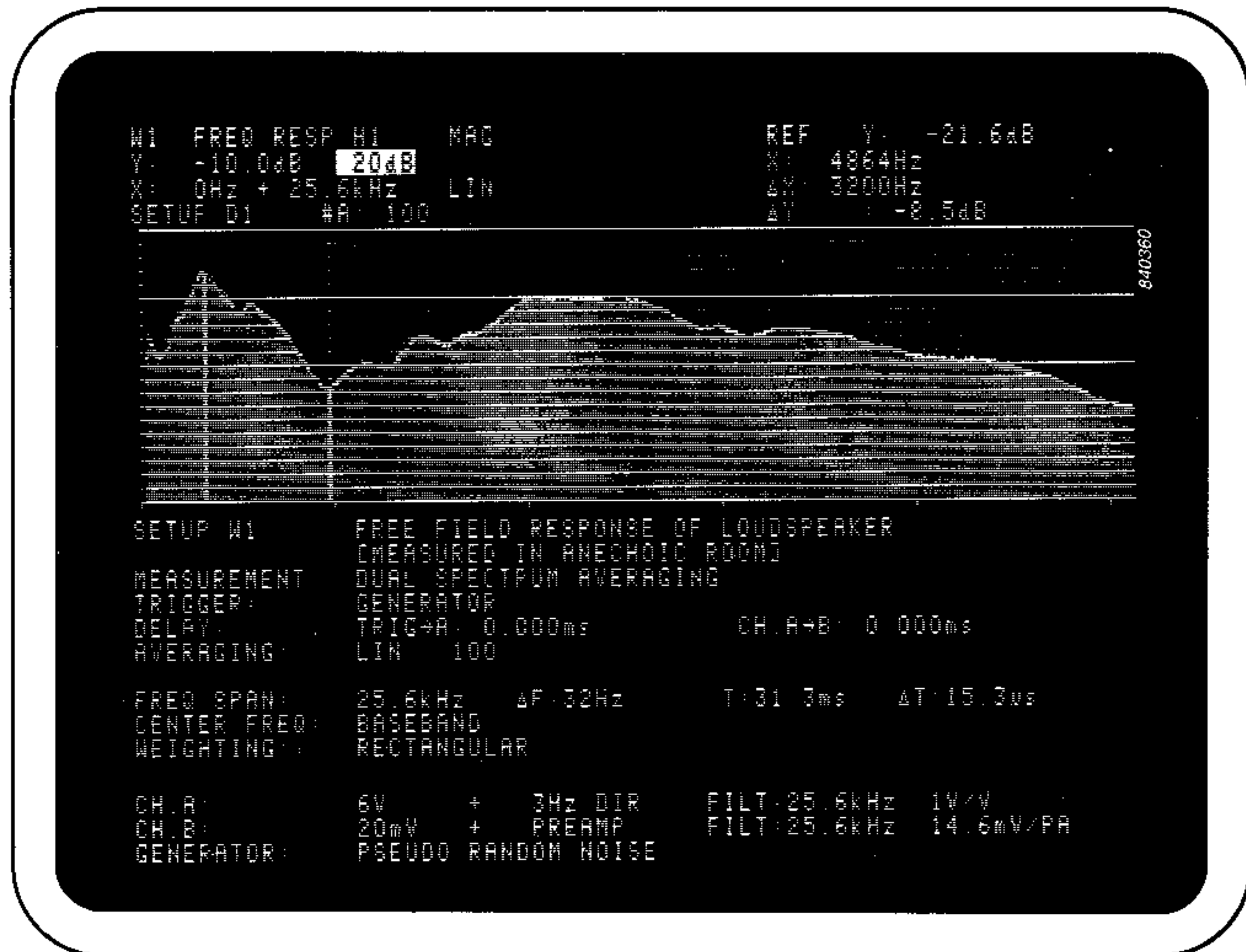

Fig. 5. The free-field response of a loudspeaker measured with pseudo-random noise excitation in an anechoic room. With this periodic type of white noise, the measurement converges more quickly towards the actual response than with true random noise excitation. The reference cursor has been set to display the maximum level fluctuation of the response

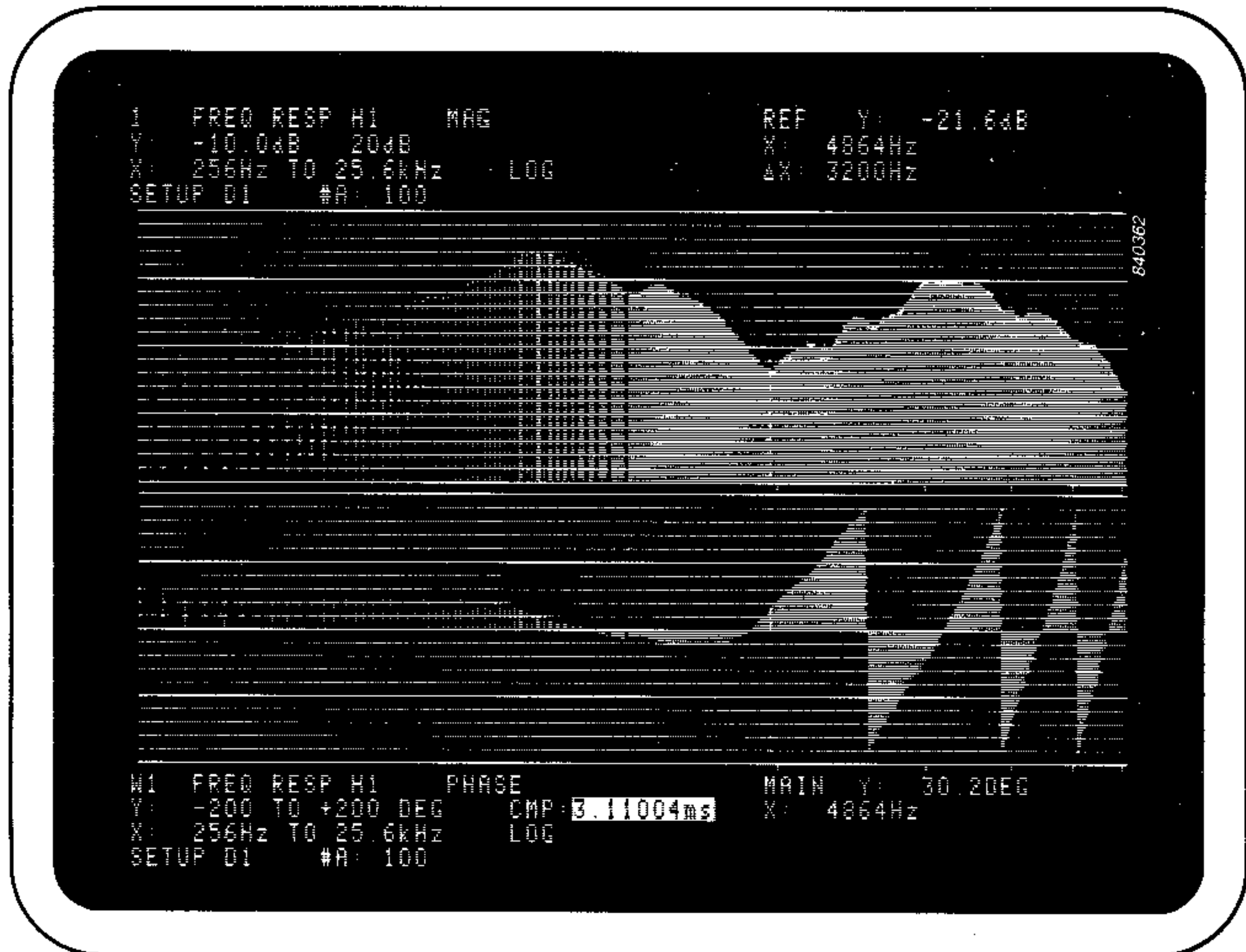

Fig. 6. The linear frequency response axis of Fig. 5, which is inherent to FFT-based analyzers, can be converted into a logarithmic axis, here showing the magnitude as well as the phase of the frequency response. Note that the phase has been compensated to take into account the delay ($\approx 3,11$ ms) between the woofer and the measurement microphone

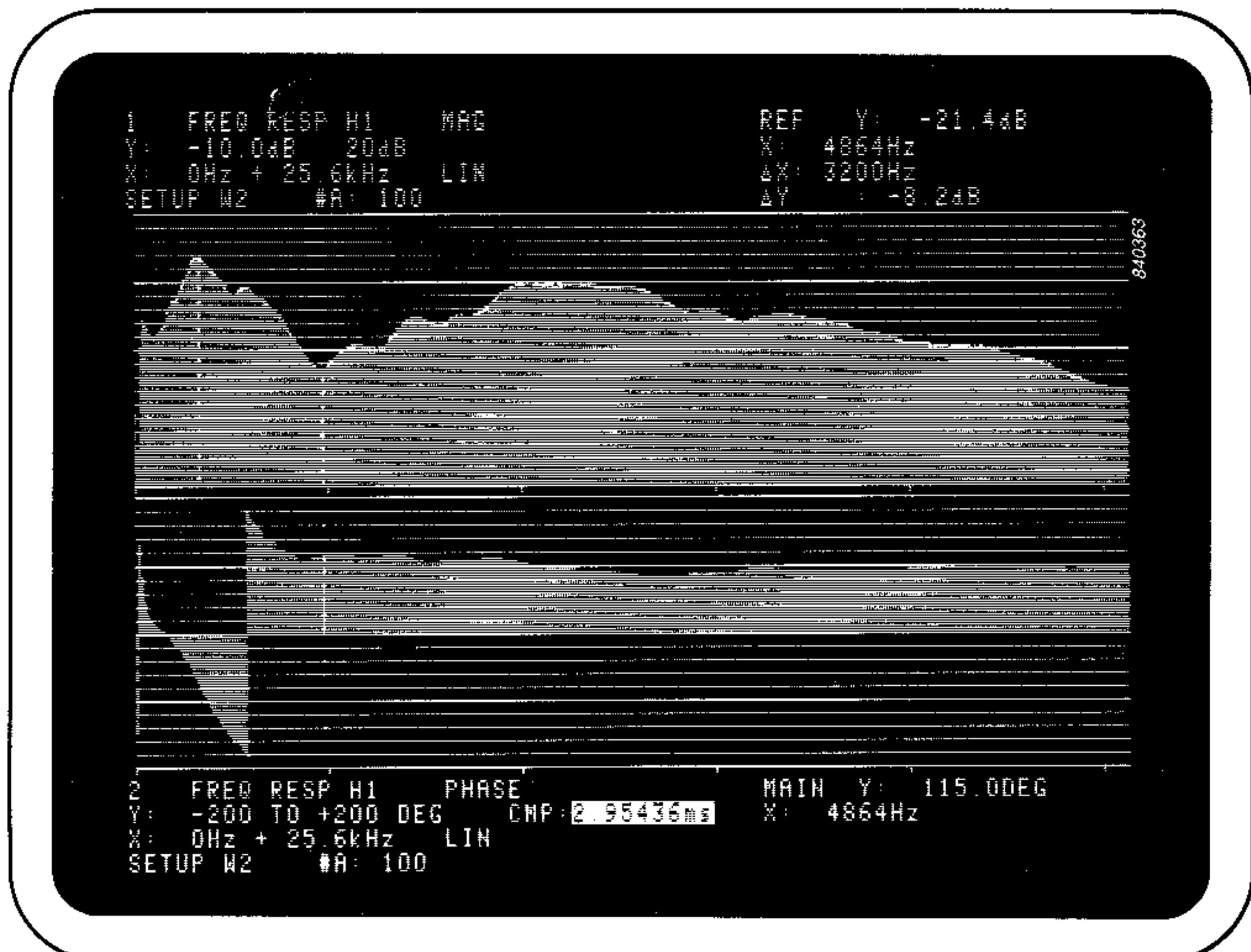

Fig. 7. Free-field response (magnitude and phase) of the same loudspeaker, but measured with the time selective impulse technique. The phase response has been compensated to account for the delay of the tweeter ($\approx 2,95$ ms). Displayed with a linear frequency axis, an offset in delay corresponds to a simple tilt of the phase response

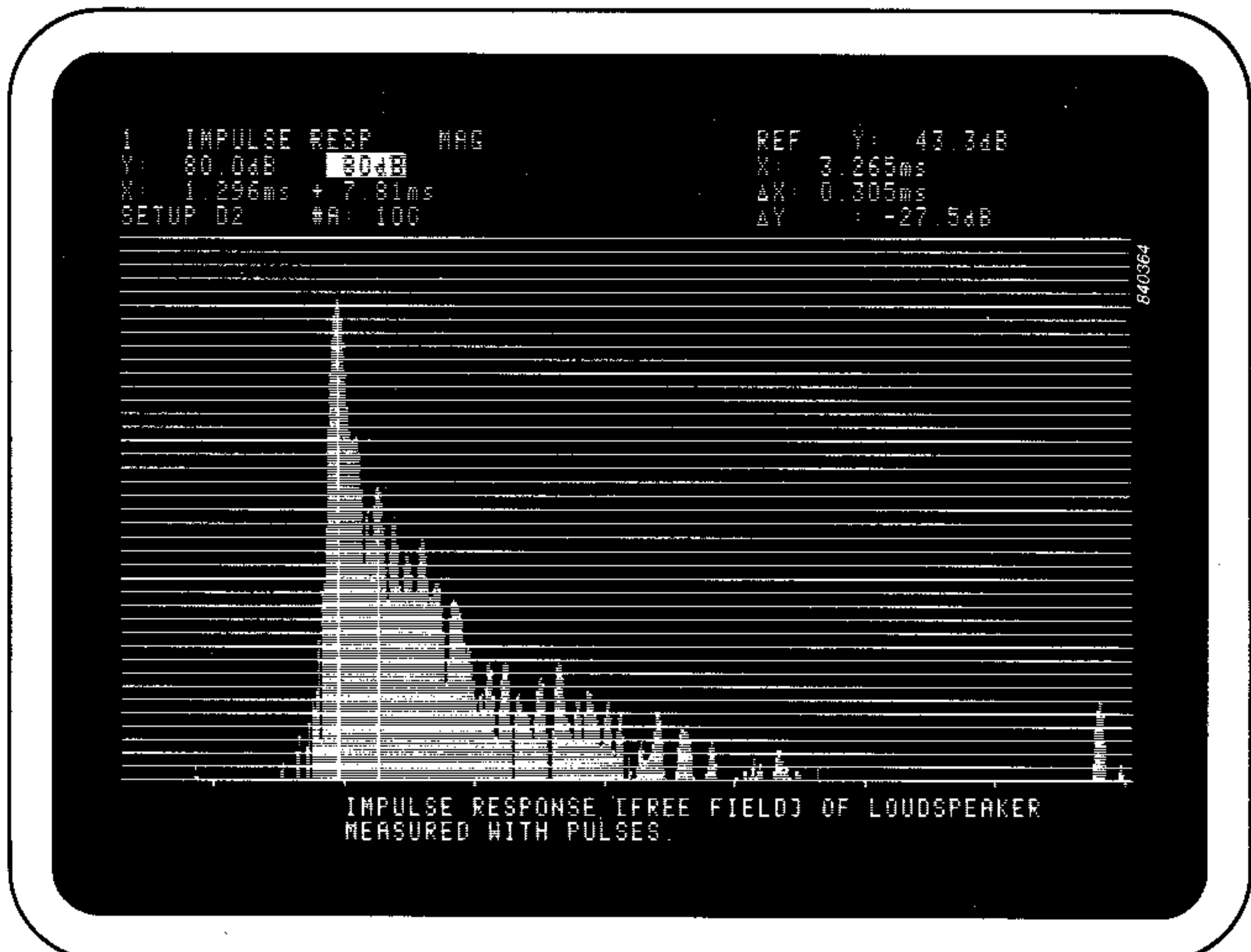

Fig. 8. Analyzers Types 2032 and 2034 allow logarithmic presentation of the impulse response magnitude. This feature vastly increases the possibilities for examination and correction of time domain discrepancies

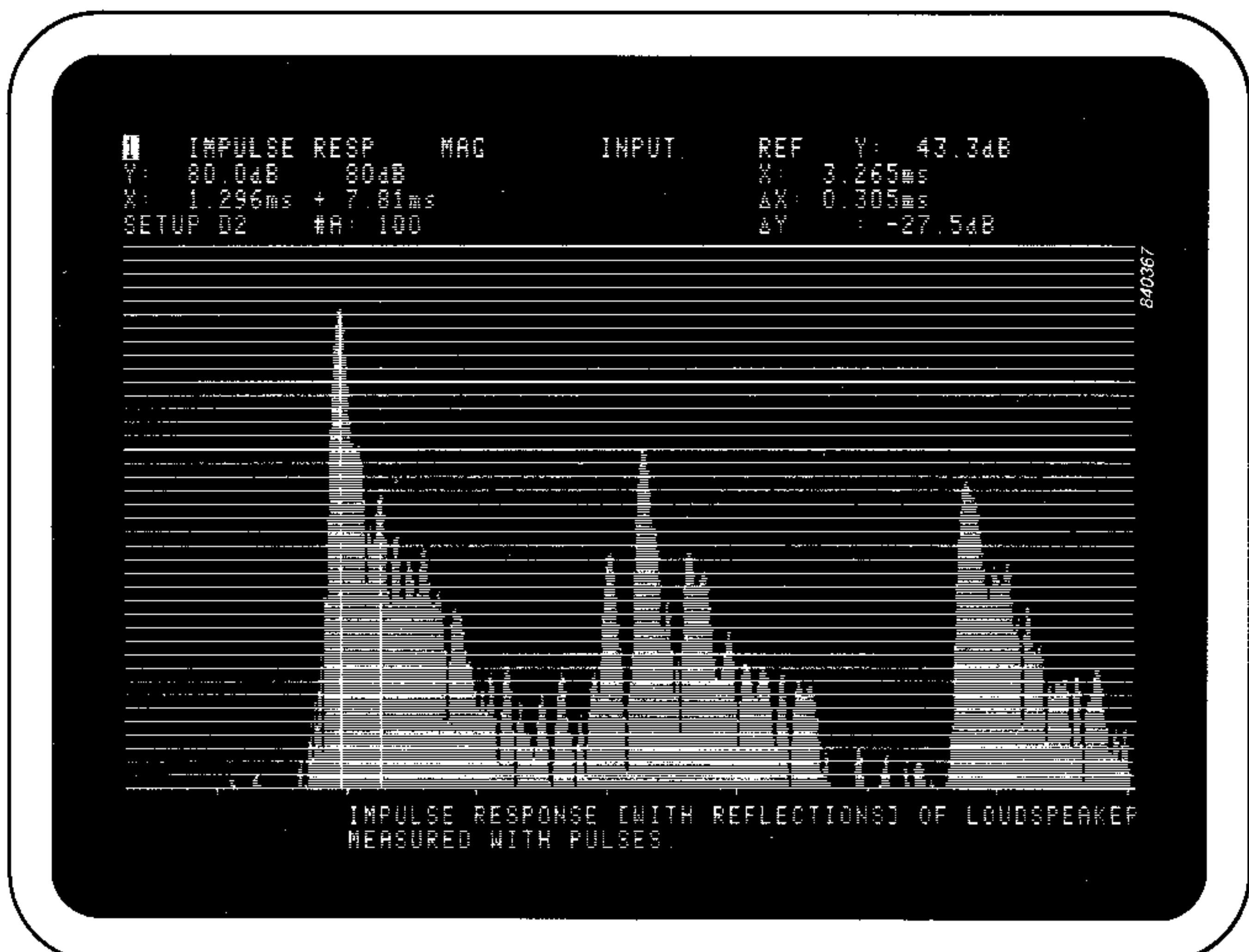

Fig. 9. Two reflective objects placed near the loudspeaker are easily identified on the impulse response display

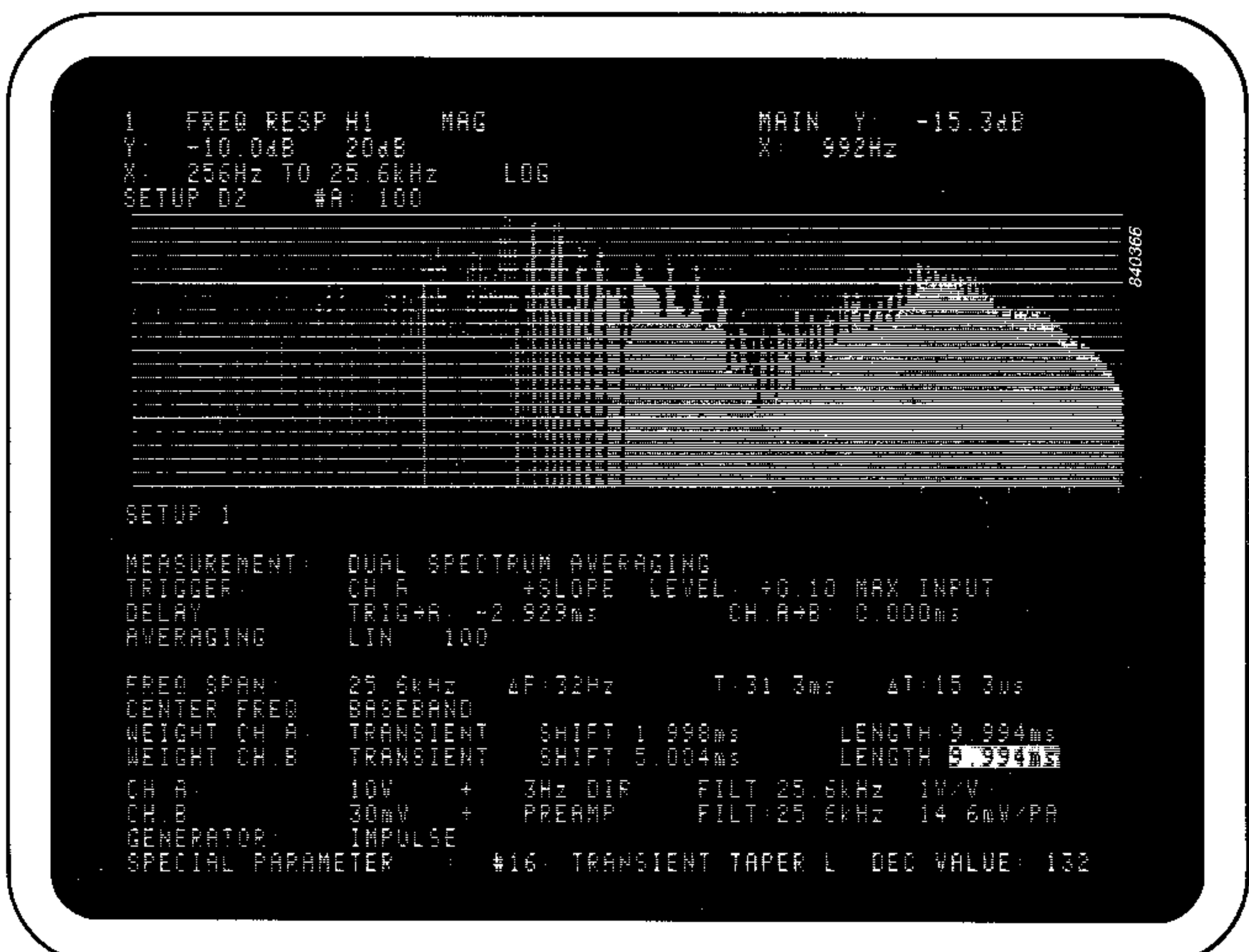

Fig. 10. From the frequency response corresponding to Fig. 9., however, it is more difficult to disclose the actual cause of the response irregularities

Directional Characteristics

The subjectively perceived "ambience" in a recording or reproduction of audio signals is related to the ratio between direct sound and reflected sound found at the listening position. This ratio is influenced by the acoustic properties of both the room and the acoustic transducers involved. The latter are normally characterized by their directional characteristics which are often visualized as polar responses at discrete frequencies. However, for

loudspeakers in particular, the off-axis responses are typically very irregular, containing deep notches at several frequencies. In general, a much better description is obtained by displaying the response in various directions relative to the on-axis response. Using the "equalized" mode of the 2032/34 the display of such relative off-axis response curves is a straightforward and simple matter, as shown in Fig 12.

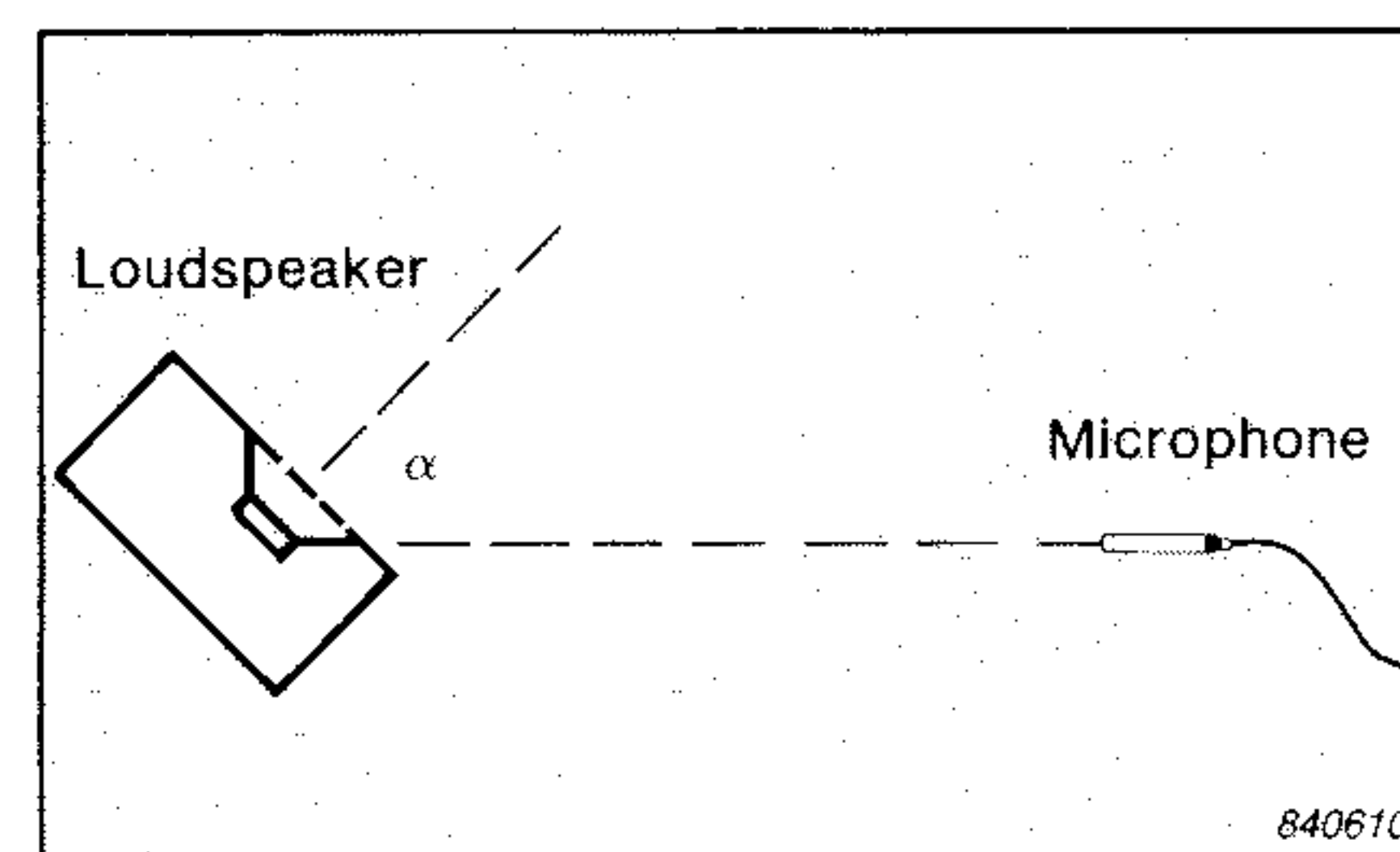
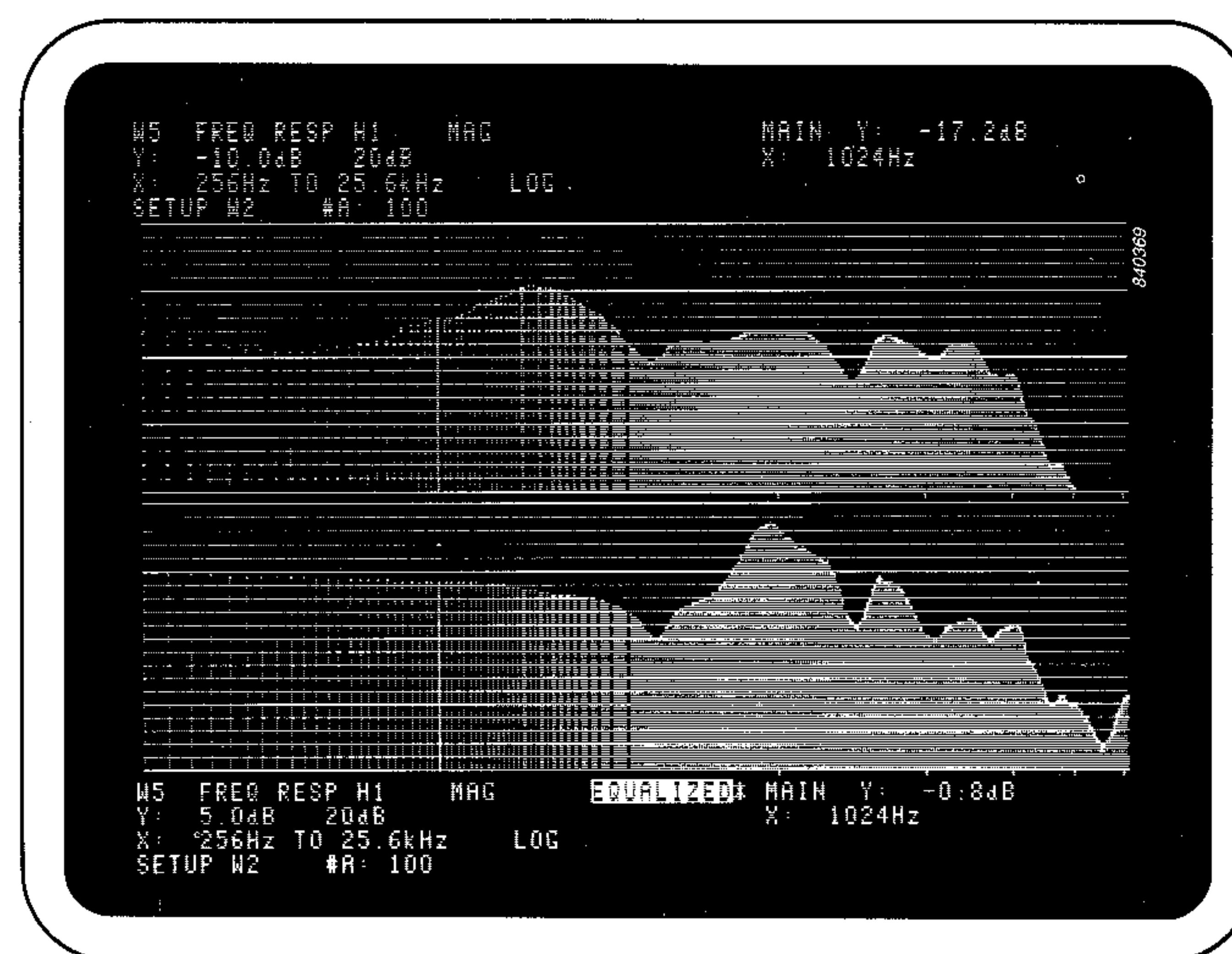

Fig. 11. The off-axis response in various directions will influence the degree of ambience in the reproduction.

Fig. 12. With the measurement speed offered by Analyzers Types 2032 and 2034, it is possible to measure complete frequency responses in each relevant direction (upper curve) and to relate each curve to the on-axis response (Fig. 6) using the equalized mode of the Analyzers (lower curve)



Microphone Measurements

For loudspeaker tests, the use of a measurement microphone with a "flat" frequency response is regarded as a basic requirement. Conversely, for microphone tests, a loudspeaker with a "flat" frequency response would be

ideal as part of a measurement system. It is almost impossible however to design a loudspeaker which fulfils the requirements for high quality microphone tests. With traditional serially swept sine measurements this

problem could be overcome using a reference microphone and a generator with compressor for instantaneous control of the output level. This principle cannot be used with the fast parallel measurements offered by the

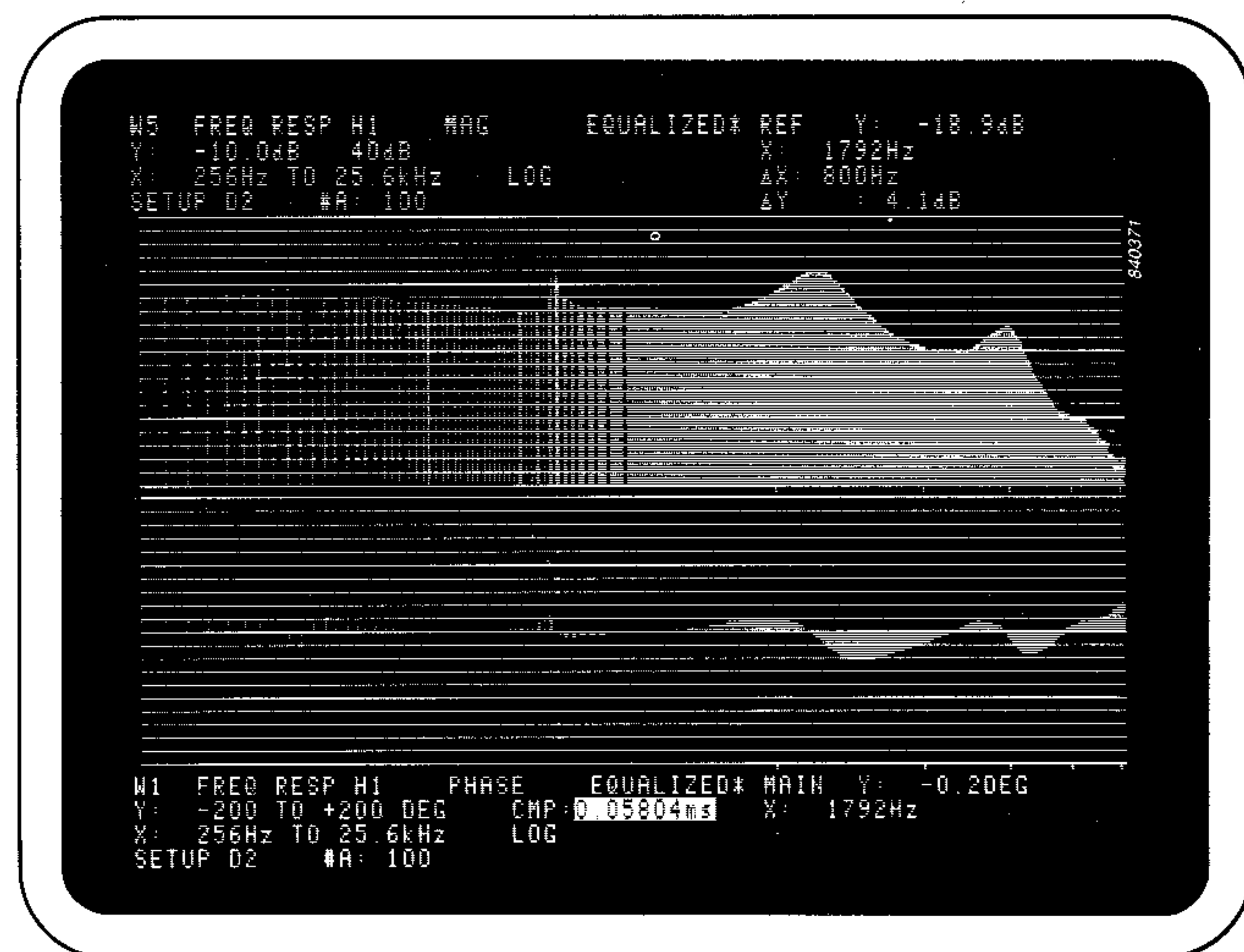

Fig. 13. The response of a microphone can be measured accurately by mere substitution of the test microphone for the measurement microphone used for the loudspeaker measurements. Using the equalized mode, the magnitude as well as the phase of the microphone response are compensated to account for the non-ideal response of the loudspeaker

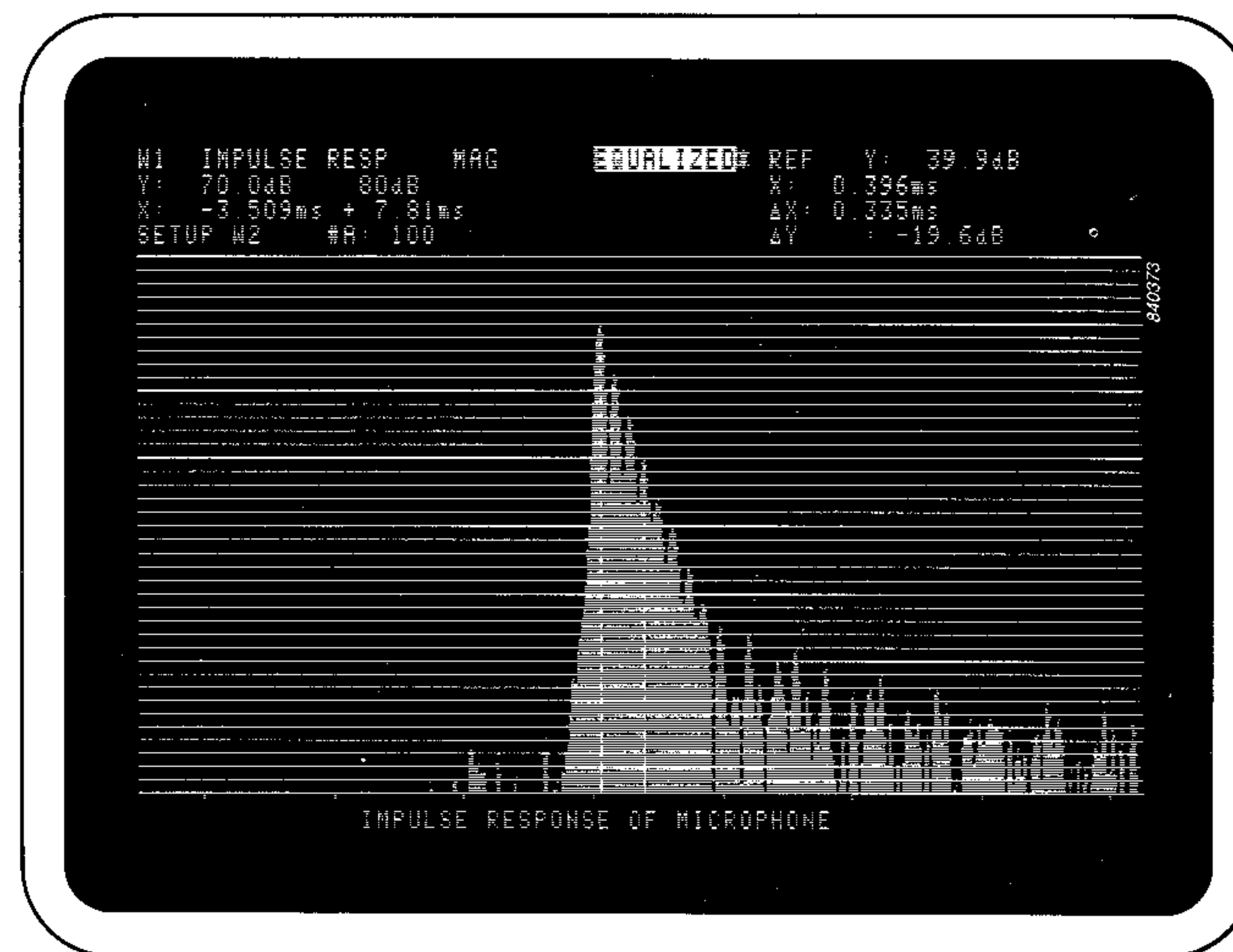

Fig. 14. Since the impulse response is obtained from the calculated frequency response rather than directly from the input data, it is also possible to extract the impulse response of a microphone from the combined response of loudspeaker and microphone. The logarithmic presentation provides direct visualization of the decay rate for the multiple reflection

2032/34. However, for measurements of essentially linear transducers, the "equalized" mode of the Analyzers can be used to carry out measurements by the substitution method, i.e. before

the microphone to be tested is positioned, a measurement microphone is mounted in its place. The resulting response is subtracted from all subsequent measurements on the test mi-

crophone (see Figs.13 and 14). An advantage of this method is that the disturbance of the sound field often caused by the reference microphone is avoided.

Low-frequency Response and Cabinet Vibration

As mentioned earlier, measurement of the free-field response of a transducer at low frequencies requires a very large room. However, at these frequencies the response measured very close to the diaphragm of the transducer, or in the case of a loudspeaker system measured inside the cabinet, is directly proportional to the far-field response. Due to the high level of direct sound at such small distances, reflections from room boundaries will not significantly influence the measurement. The theory of the near-field technique is described in detail by Keele^[3]. Fig 16 shows the low frequency free-field response of the test loudspeaker, measured in an anechoic room (upper curve) and using the time selective impulse technique (lower curve). The standing waves present in anechoic rooms at low frequencies are normally observed as a frequency ripple, gradually increasing in level for decreasing frequency. In a room of equal size the time selective technique will often provide reliable results to frequencies approximately one octave below the useful low frequency limit of the anechoic room. The near-field response shown in Fig.17 (upper curve) confirms the

close relationship between near-field and free-field sound pressure at low frequencies. Although the sound power measurement (described later) provides an even better basis for estimating the low frequency response of the loudspeaker under realistic conditions, the more simple near-field measurements are useful for fine tuning of the cabinet design as well as for quality control.

The acceleration of a loudspeaker diaphragm (Fig.17., lower curve) is directly proportional to the resulting near-field sound pressure. At frequencies where the diaphragm moves as a rigid piston (i.e. no break up modes are excited) the measurement microphone can be directly replaced by an accelerometer mounted near the joint between the voice coil and diaphragm. This measurement provides a relevant basis for investigation of the loudspeaker cabinet. A comparison of the cabinet vibration at different positions with the acceleration of the diaphragm itself allows a measure of the audibility of the cabinet vibration to be obtained. In addition to giving an indication of whether or not the cabinet has sufficient stiffness etc., mea-

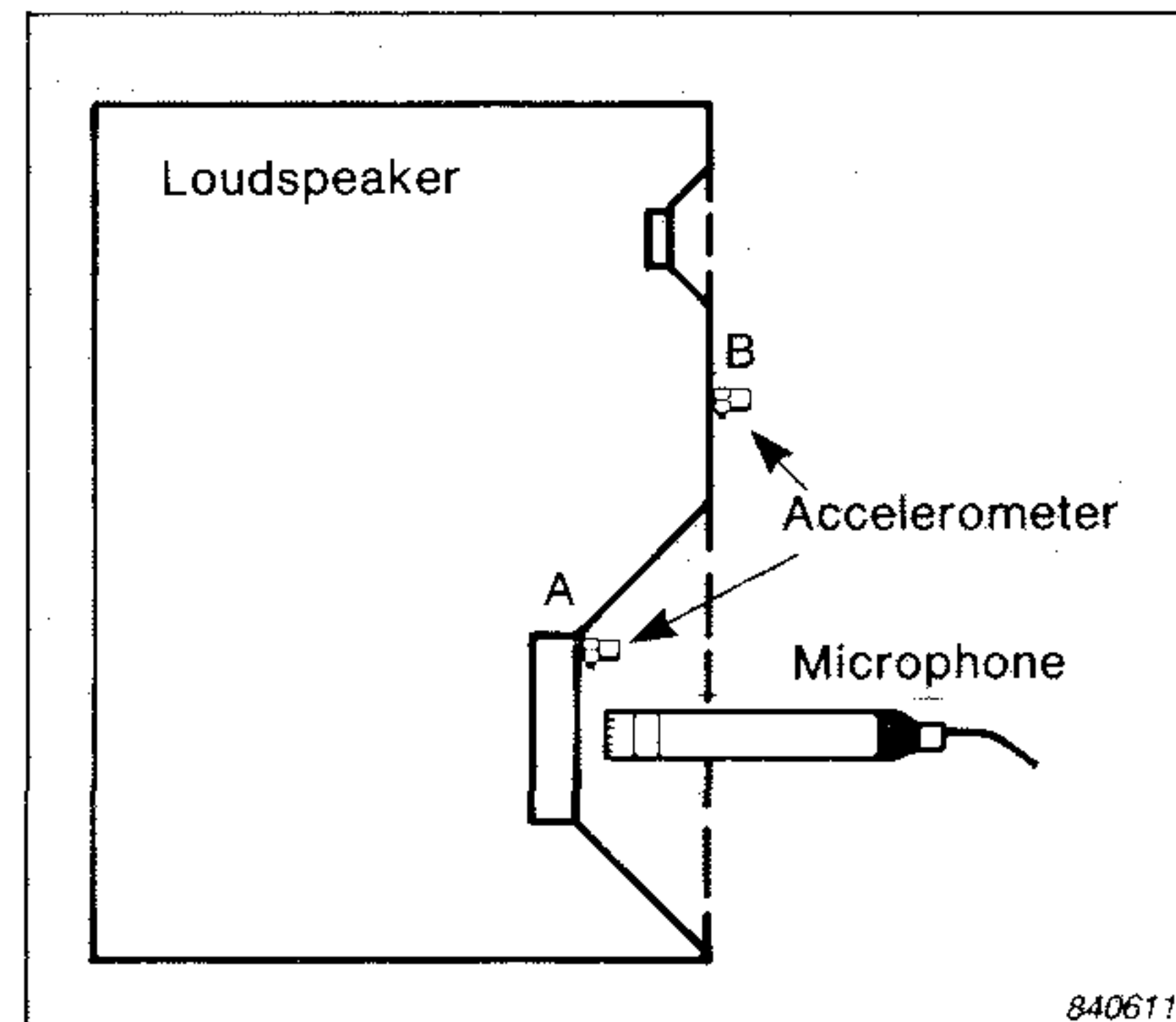

Fig.15. For the measurement of the near-field response, the microphone should be placed near the centre of the diaphragm. Cabinet vibration is measured by placing a small accelerometer at various positions on the loudspeaker cabinet. Measurement of the acceleration near the joint between the voice coil and the diaphragm can be used as a reference

surements of both magnitude and phase will give clues to how the cabinet vibration can be reduced. See Figs.18 and 19. For systematic analysis of the eigenmodes of a loudspeaker and the possibility for animation and simulation of structural modifications, B & K can supply modal analysis software.^[4]

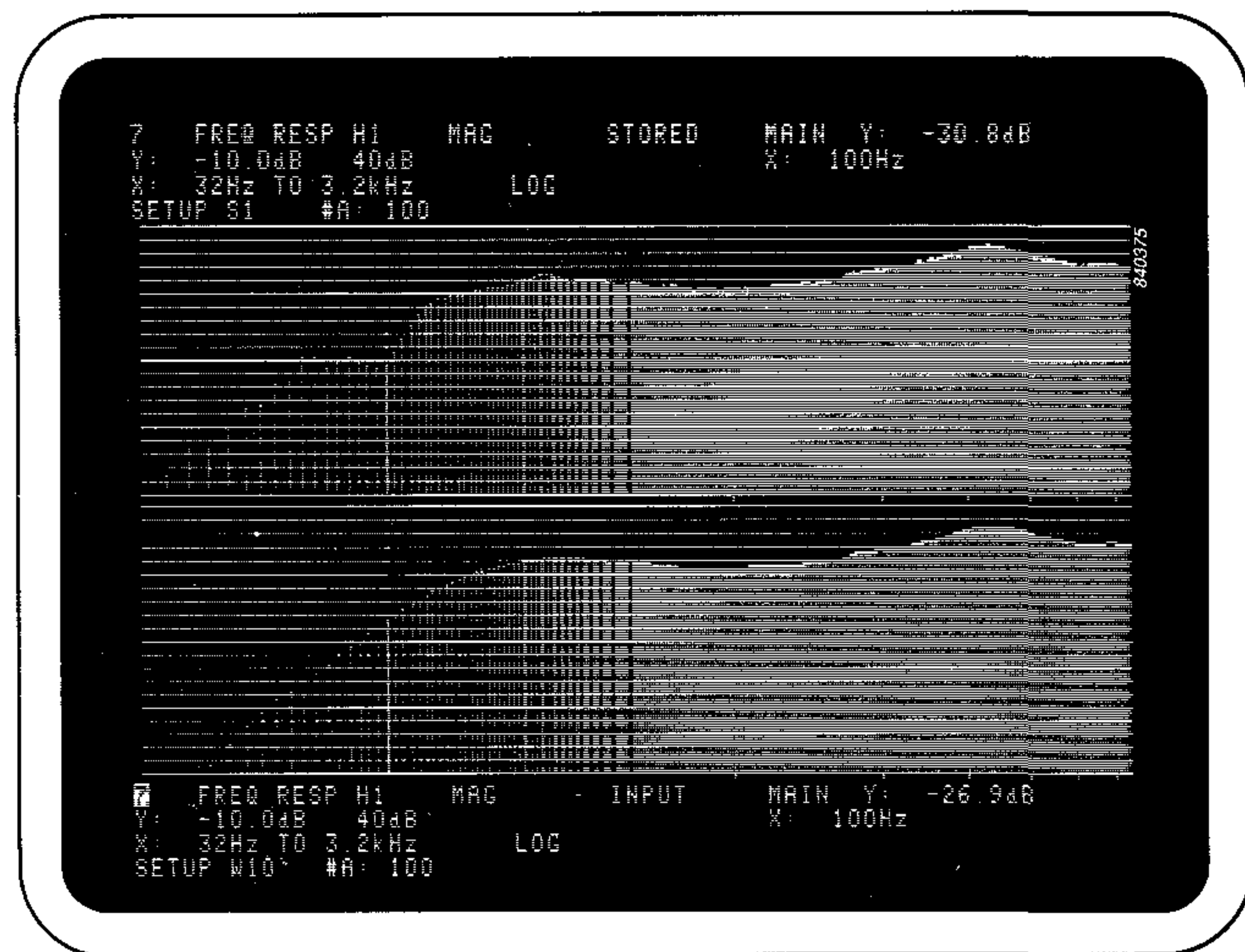

Fig.16. Low frequency free-field response of a small loudspeaker system measured in an anechoic room (upper curve) and using the impulse method in an ordinary room of equal dimensions (lower curve). The irregularities of the anechoic response seen around the cursor position are due to the presence of standing waves as the acoustical absorption at the room boundaries is not sufficient at these low frequencies.

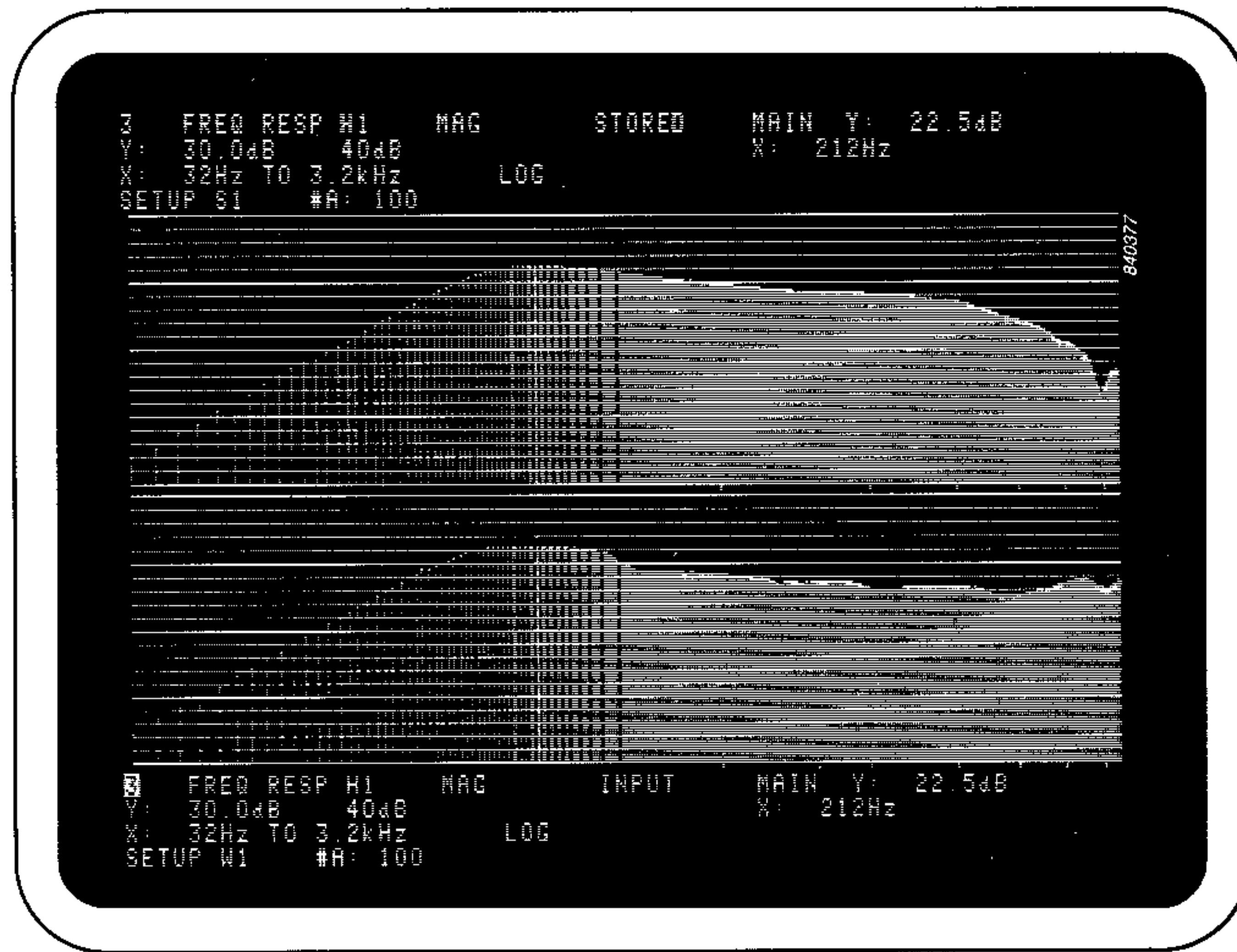

Fig.17. Near-field response (upper curve) and diaphragm acceleration (lower curve) of the same loudspeaker used for the measurements in Fig.16. With the near-field technique there is no low frequency limit. The measured response shows good agreement with the free-field response for frequencies up to approximately 600Hz. Below 300 Hz the diaphragm acceleration is seen to be directly proportional to the near-field response, indicating that in this frequency range the diaphragm behaves like a rigid piston

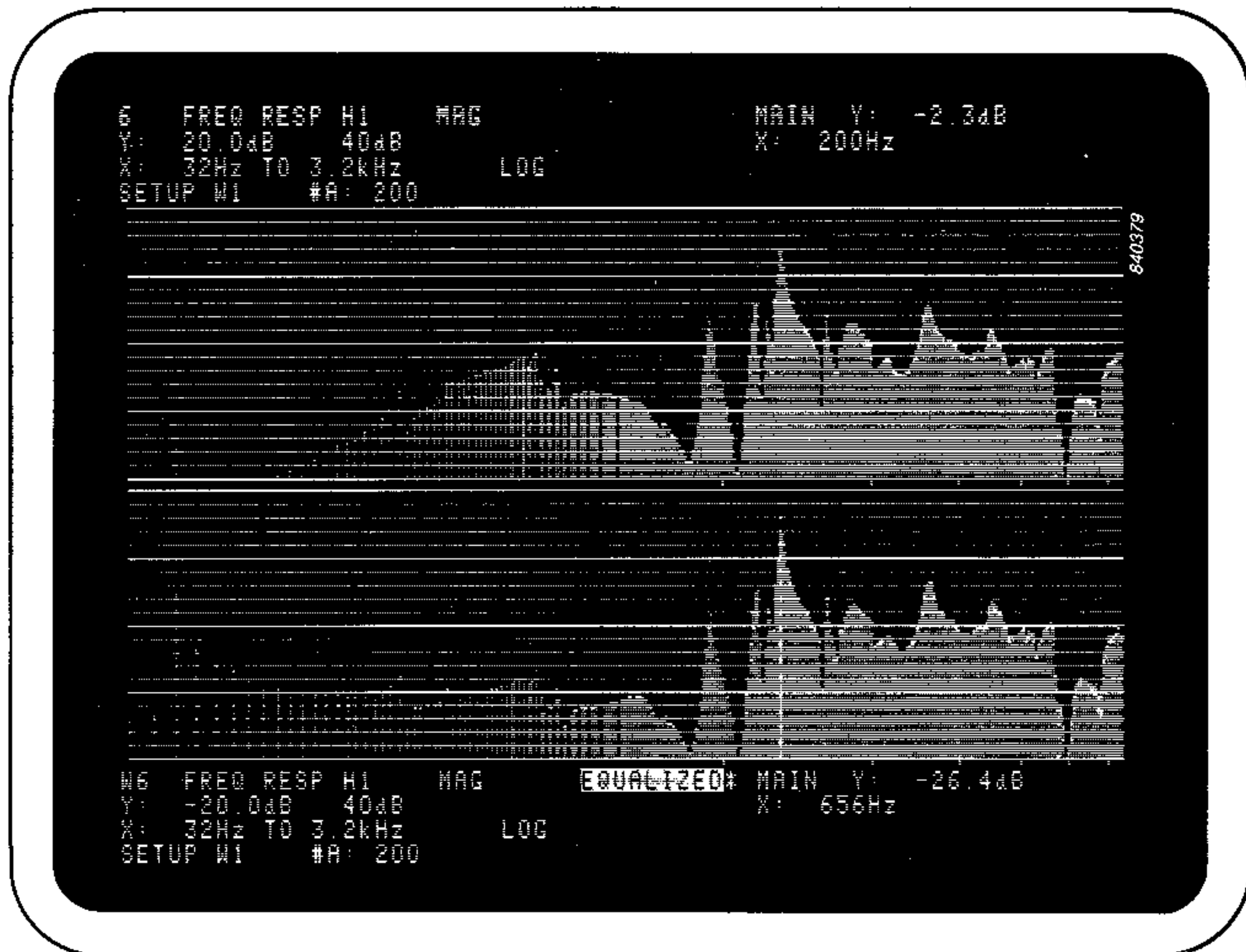

Fig. 18. Absolute level of front baffle vibration (upper curve) and baffle vibration relative to diaphragm movement (lower curve). Since the sound pressure resulting from this vibration is proportional to the vibrating surfaces, colouration related to cabinet vibration is generally a more severe problem with loudspeakers with large panel areas

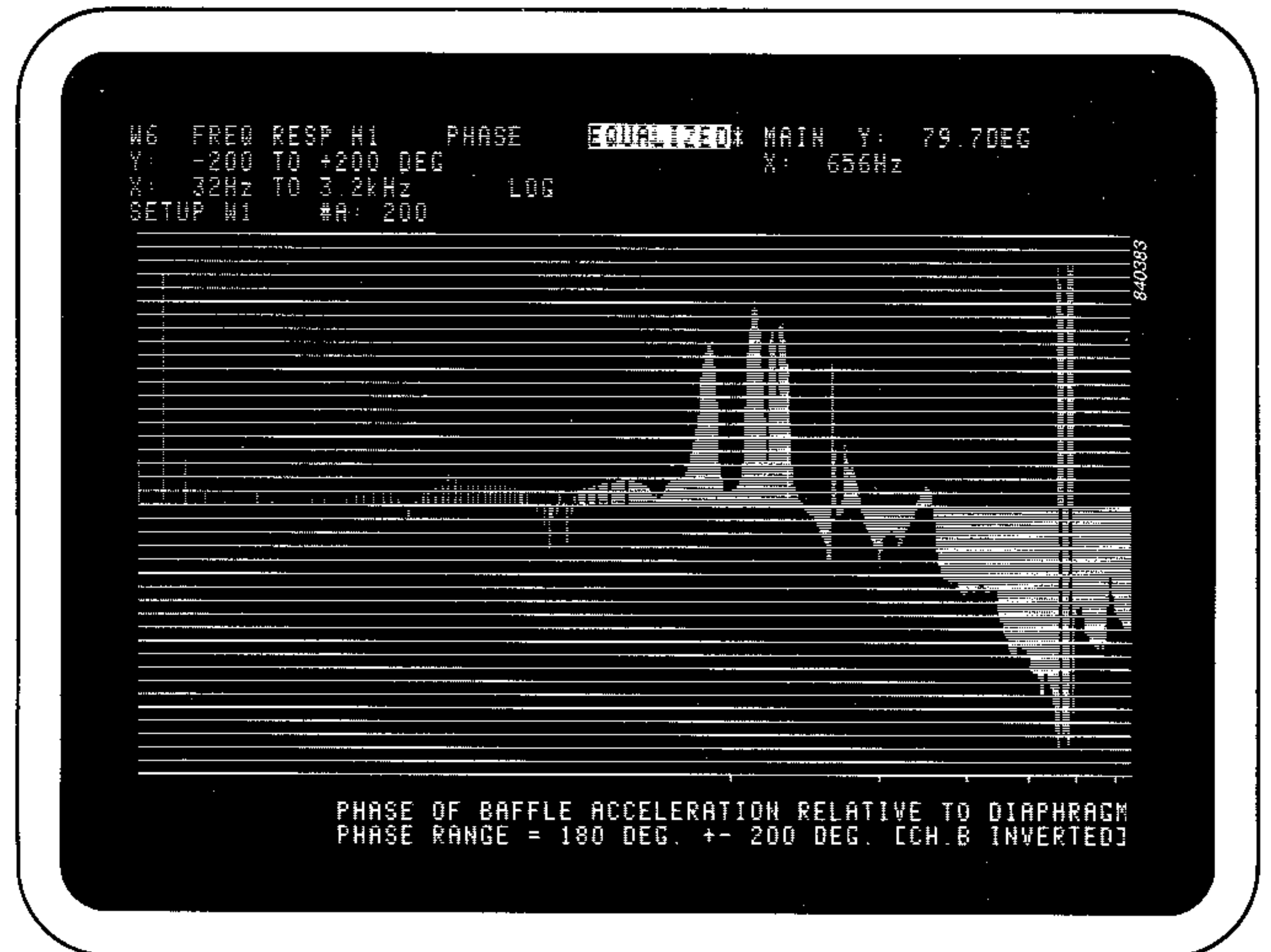

Fig. 19. Phase response corresponding to the lower curve of Fig. 18. In the low frequency range the phase of the baffle vibration is 180° out of phase with the diaphragm movement. (Note: shifted phase range due to polarity reversal in channel B). This is a direct consequence of Newton's second law and a lack of mechanical isolation between the loudspeaker chassis and the front panel

Sound Power

At low frequencies where the wavelength is comparable with the dimensions of the room, it is no longer justified to separate the sound field in direct and reverberant sound. At these frequencies the loudspeaker-room-listener combination should ideally be treated as a whole. The most important isolated parameter for the loudspeaker is its total radiated sound power. Traditionally the use of either an anechoic or reverberant room has been necessary for measurement of sound power (Fig. 20). With Types 2032/34 such rooms are no longer required since these Analyzers have built-in provision for sound intensity measurements.

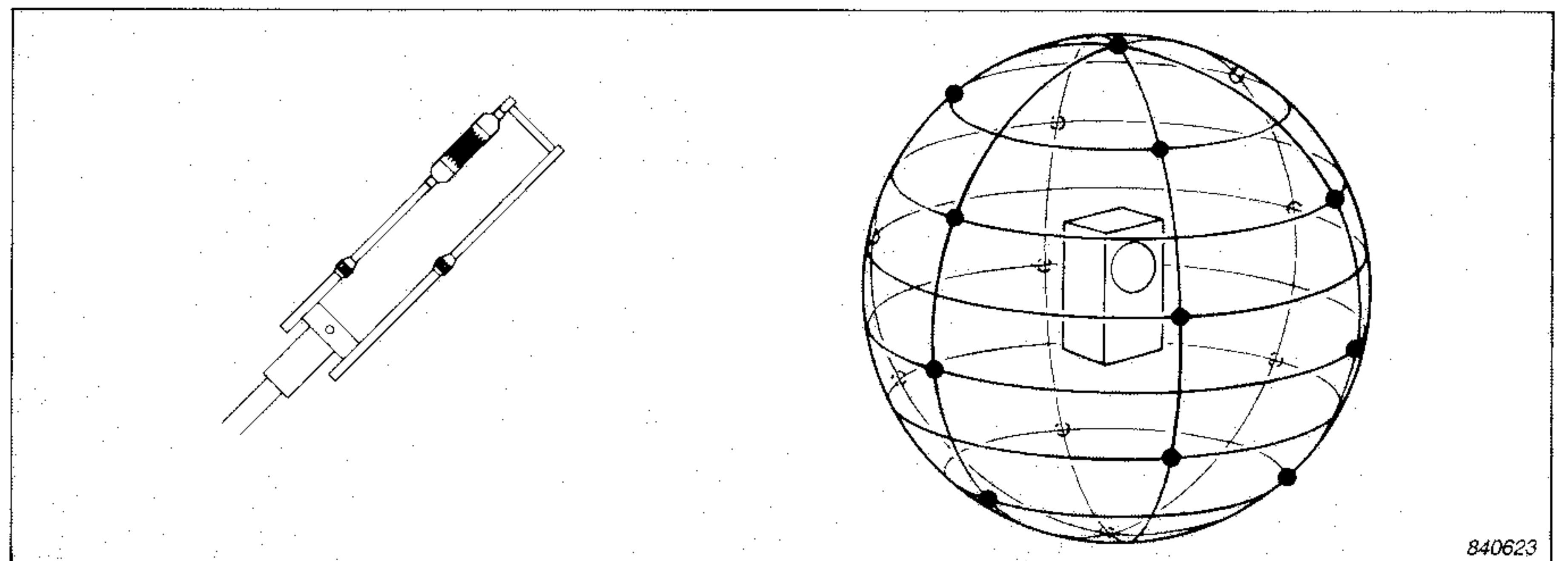

Fig. 20. To estimate the total sound power output of a loudspeaker, the sound intensity probe (left), or in the case of measurement in an anechoic room the measurement microphone, must be moved to a large number of positions on a hypothetical surface surrounding the loudspeaker. For an equal number of averages at each position these should represent areas of equal size (right)

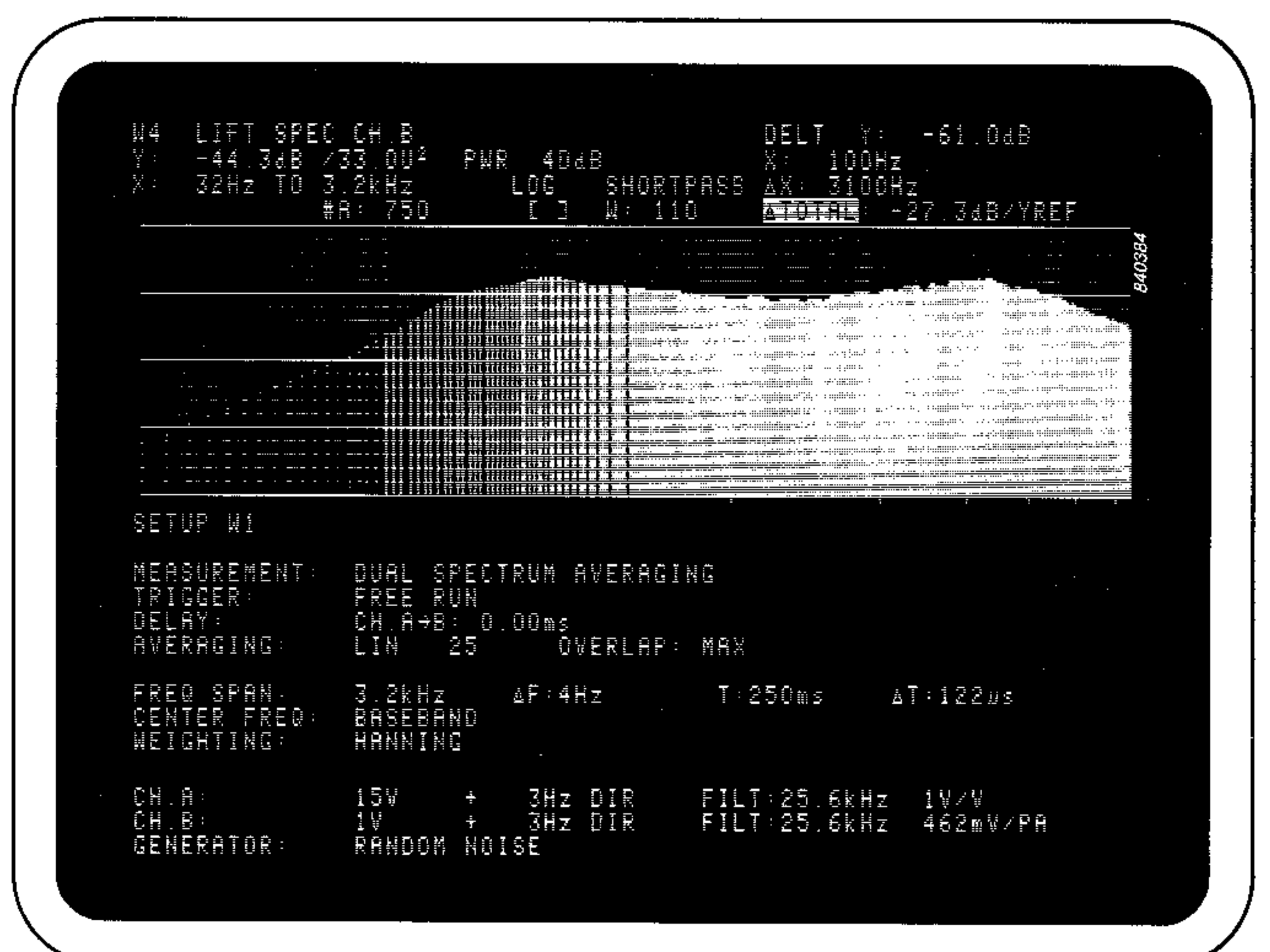

Fig. 21. Sound power output for 1 W electrical input in the frequency range 100 Hz to 3.2 kHz. The sound power is measured by averaging the sound pressure at 30 positions on a sphere (4π steradians) around the loudspeaker in an anechoic room. The resulting power spectrum has been "liftered" (= smoothed) for easy comparison with Figs. 16 and 17. The " Δ TOTAL" field indicates an acoustical output of -27.3 dB relative to 1 W in the chosen frequency band

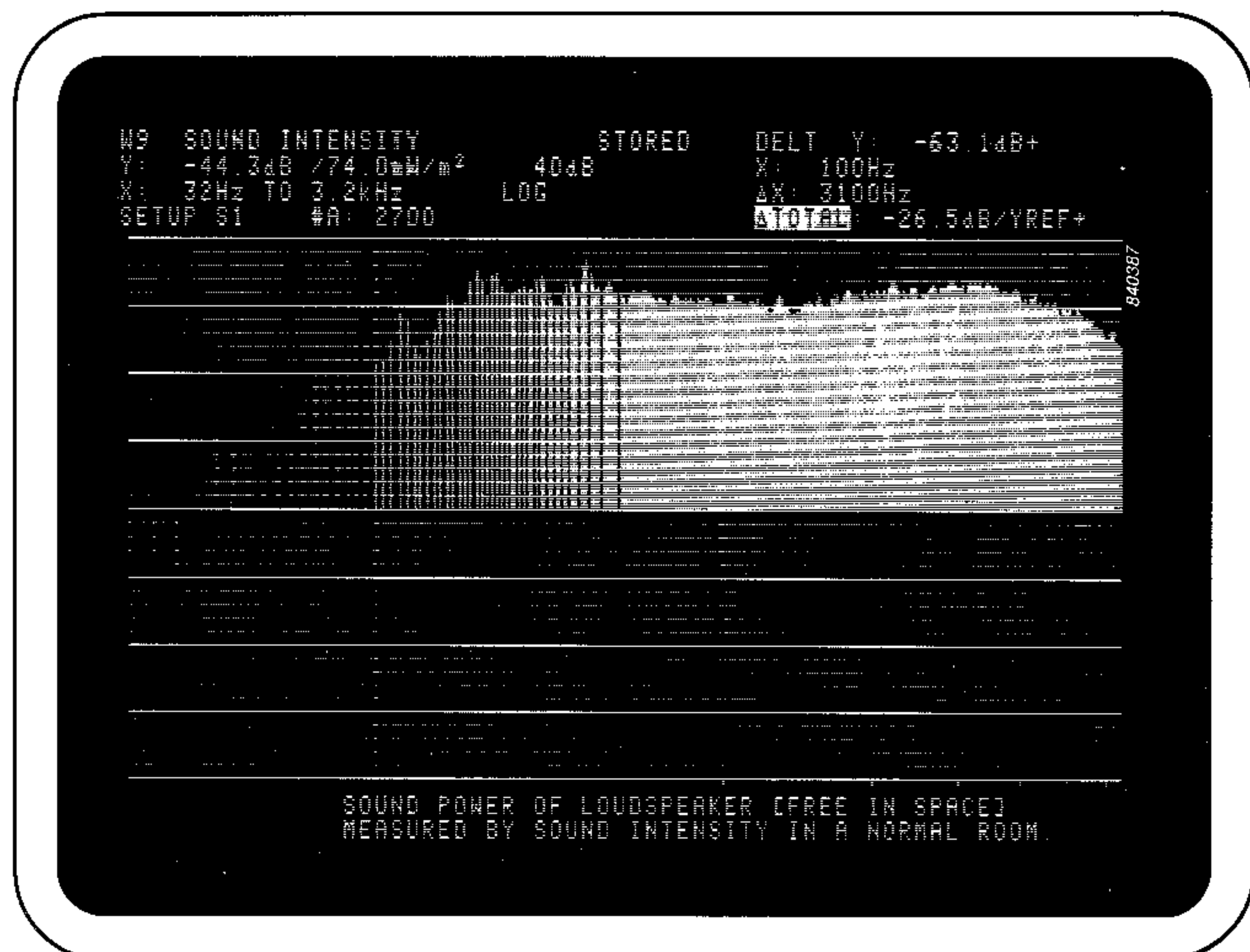

Fig. 22. Sound power output for 1W electrical input. The sound power is measured by averaging the sound intensity at 54 positions on a cube (4π steradians) around the loudspeaker in an ordinary room. With the probe configuration used, the measurement results are valid at frequencies down to approximately 100Hz. Measurement at lower frequencies requires a larger gap between the two microphones in the probe. Response below the centre horizontal axis indicates a negative intensity

Averaging the sound intensity (= sound power per unit area) measured at various points on a closed surface surrounding the loudspeaker, the sound power emitted by the loudspeaker when it is placed in realistic positions in a normal room can be directly measured (Figs. 22 and 23). Most loudspeakers will double their output power at low frequencies when the effective angle of radiation is halved, for example, when changing

Electrical Impedance

The electrical impedance of a loudspeaker is important with regard to interface with a power amplifier. Often the reactive load associated with a loudspeaker will cause the maximum undistorted output from a power am-

plifier to drop by a factor of 10 or more compared with a corresponding resistive load. The impedance is usually represented either by its magnitude or by its Nyquist plot, i.e. the real part of the impedance versus the imaginary

For measurement of sound intensity, the measurement microphone must be replaced by a special probe, B & K

Type 3519, since both the sound pressure and the particle velocity must be measured in order to calculate the sound intensity.^[5]

The sound intensity mode of the Analyzers is also very useful for obtaining a detailed mapping of the sound field near a loudspeaker. This is used to evaluate how physical modifications of the loudspeaker cabinet will influence the response.

The sound intensity mode of the Analyzers is also very useful for obtaining a detailed mapping of the sound field near a loudspeaker. This is used to evaluate how physical modifications of the loudspeaker cabinet will influence the response.

part. The "MASK" cursor of the 2032/34 is very helpful when examining the impedance curve near the individual resonances. It enables selective display of specific parts of a measured response curve. See Fig. 24.

Fig. 24. Linear magnitude and Nyquist plot of loudspeaker impedance. A large (800 line) Fourier Transform is essential for obtaining an adequate resolution for simultaneous measurement of both resonance peaks. The "MASK" cursor used with the Nyquist plot helps eliminate the confusion often associated with such plots. The trace represents the frequency range indicated by the delta cursor in the upper display. Each resonance peak in the impedance plot will correspond to a full circle in the Nyquist plot

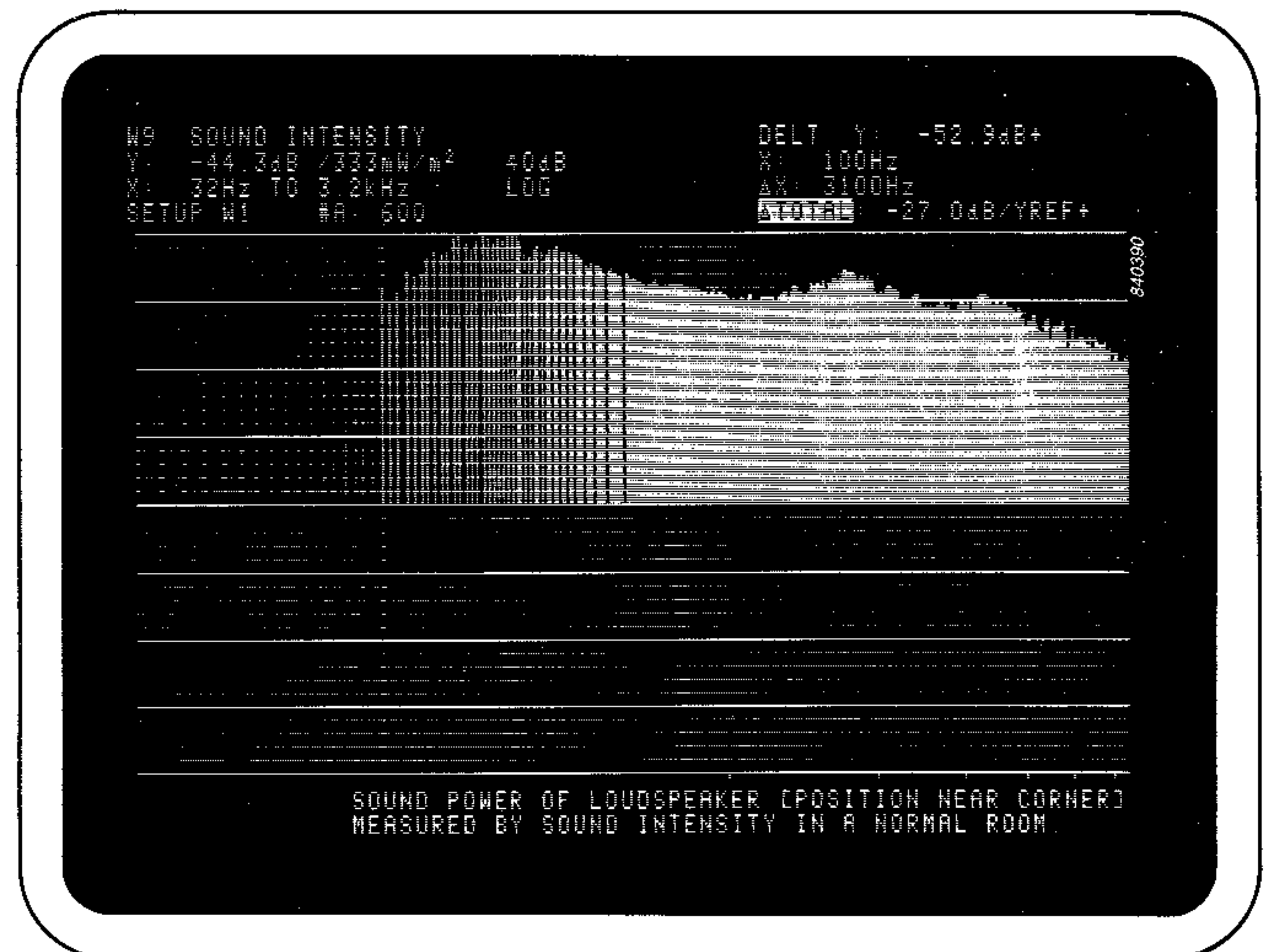
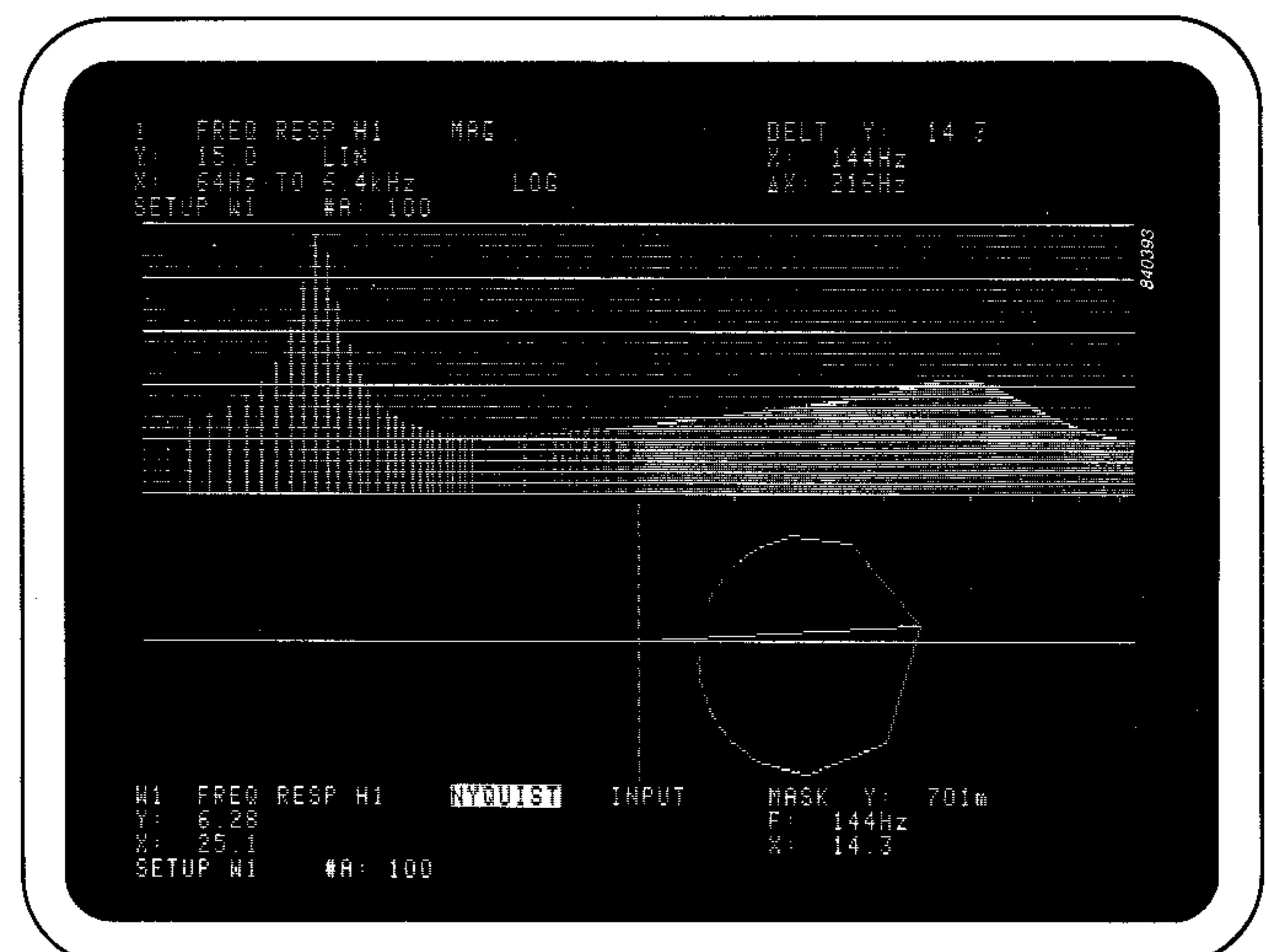

Fig. 23. Sound power measured as in Fig. 22, but with the loudspeaker positioned near a corner where the acoustical impedance better matches the radiation impedance of the speaker. This results in a higher acoustical output in the low frequency range. Due to the absorbing surfaces near the corner, the response in the upper part of the displayed range is lower than the response shown in Fig. 22



Harmonic Distortion

Generally an anechoic room is required for measurement of non-linear distortion. However, as the non-linearities associated with loudspeaker units are generally related to the displacement of the diaphragm (finite length of voice coil and magnetic gap, displacement limited suspension etc.) harmonic distortion will normally be a greater problem at low frequencies near the fundamental resonance fre-

quency of the loudspeaker. In this frequency range the near-field technique may be used with the 2032/34 generator in its variable sine mode, allowing measurement of harmonic distortion down to approximately -60dB relative to the fundamental. To avoid the influence of background noise, harmonic distortion should normally be calculated by adding the individual harmonics rather than by a

total integration of all lines in the spectrum except the one line containing the fundamental. In order to obtain exact level estimation and to benefit from the use of the harmonic cursor of the 2032/34, the generator frequency should be centered precisely in one of the displayed frequency bands, as shown in Fig. 25.

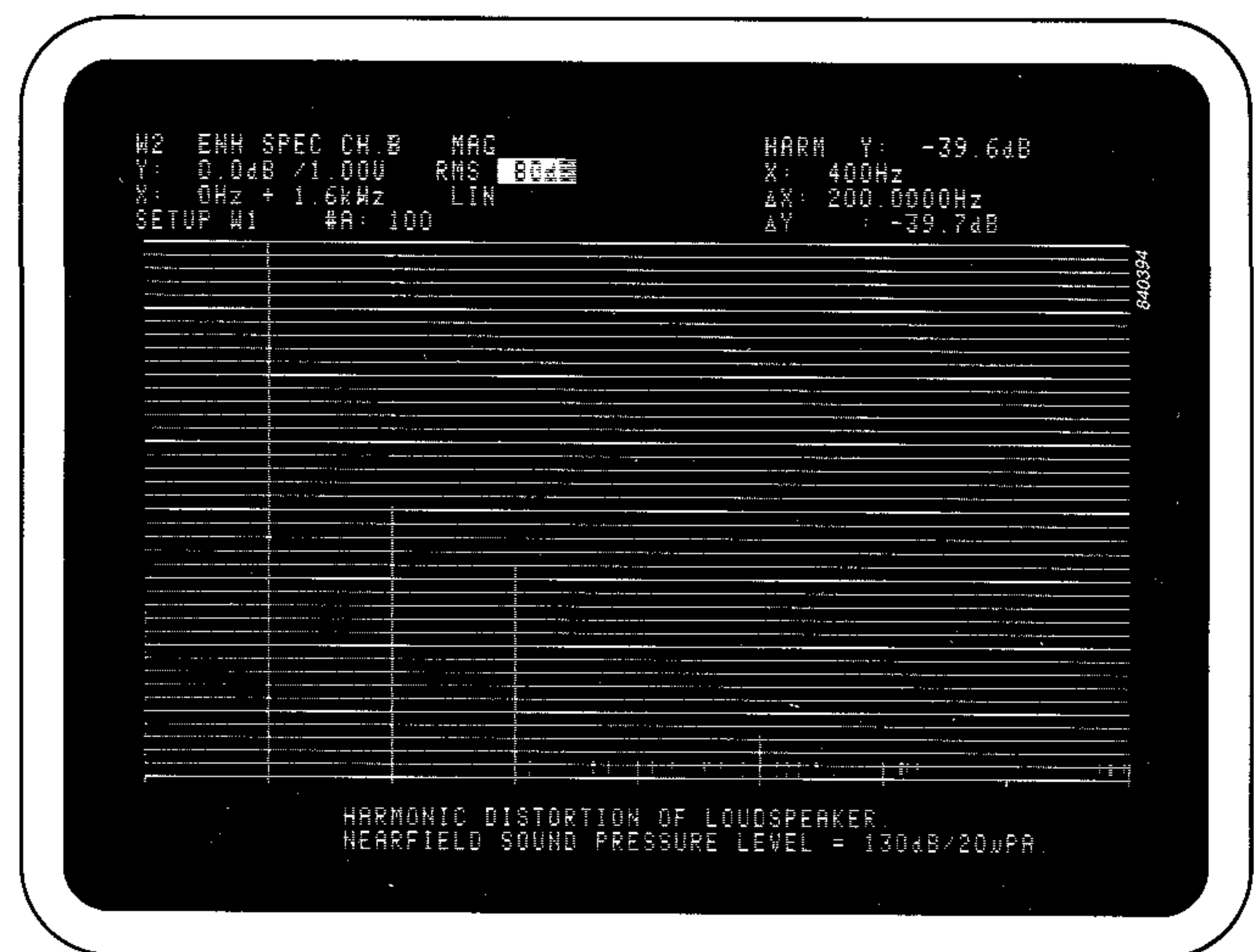

Fig. 25. Near-field measurement of harmonic distortion measured near the low frequency resonance of the loudspeaker. However, the sound pressure level should normally refer to the level at 1m distance from the loudspeaker. The cursor indicates a second harmonic distortion of $-39,7\text{dB}$ relative to the fundamental

Conclusion

Dual Channel Signal Analyzers Types 2032 and 2034 are self-contained measurement systems that effectively dispense with many of the difficulties traditionally associated with acoustic measurements. Even complex measurements can be carried-out with a minimum of peripheral equipment. The measurement results

illustrated in this *Application Note* are shown as they appear on the large display screen of the Analyzers, without the need for any special user-programming or additional post-processing.

The presence of the sophisticated, but user-friendly IEC 625-1 (\approx IEEE

488) interface further opens up a virtually endless range of measurement, post-processing and display possibilities when the Analyzer is connected to a B & K Graphics Recorder Type 2313 or to a desk-top calculator. In this way the Analyzers are easily adapted to various user-specific requirements.

References

- [1] Ingerslev, F., Pedersen, O. J., Møller, P. K., & Kristensen, J. "The Anechoic Chambers at the Technical University of Denmark", Brüel & Kjær Technical Review No.2, 1968
- [2] Biering, H., & Pedersen, O. Z., "System Analysis and Time Delay Spectrometry (Part 1)", Brüel & Kjær Technical Review No.1, 1983
- [3] Keele, D. B., "Low Frequency Loudspeaker Assessment by Nearfield Sound-Pressure Measurement", Loudspeakers — An Anthology of Articles on Loudspeakers from the pages of the Journal of the Audio Engineering Society Vol.1–Vol.25 (1953 – 1977), 2nd Edition, 1978, pp. 344–352
- [4] "Programs for Structural Analysis, WT9100, WT9101, WT9102 & WT9103", Brüel & Kjær System Development Sheet, BU0044–11, 1984
- [5] Gade, S., "Sound Intensity (Part 1 Theory)", Brüel & Kjær Technical Review No.3, 1982

Electroacoustic Measurements the B & K Way

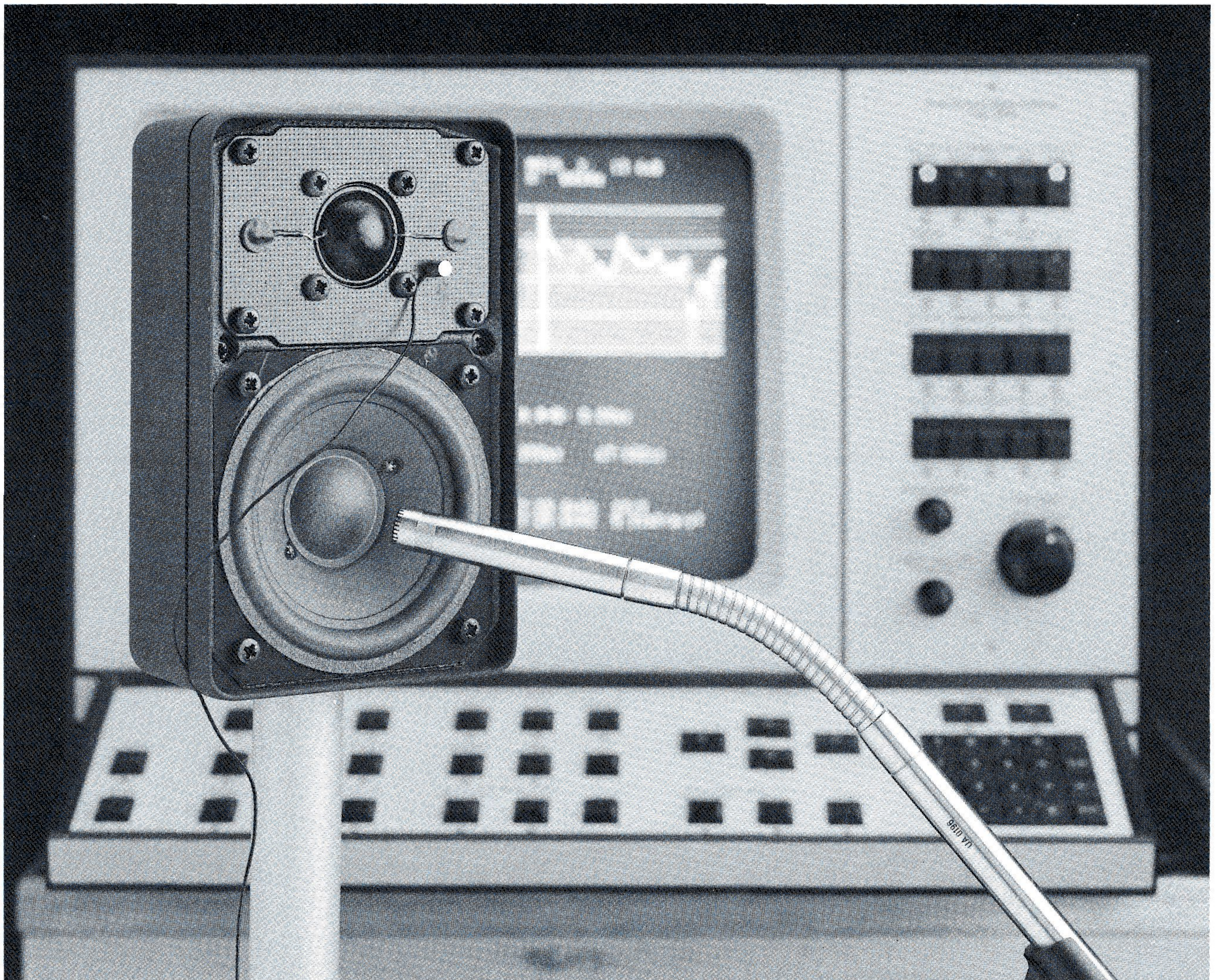

...with Dual Channel FFT Analyzers 2032 & 2034



Brüel & Kjær Instruments, Inc.

185 Forest Street, Marlborough, Massachusetts 01752 · (617) 481-7000 · TWX: 710-347-1187

Regional Offices: MA (617) 481-7000 ext. 139; NJ (201) 227-6100; MD (301) 948-0494; GA (404) 951-0115;

MI (313) 522-8600; IL (312) 358-7582; TX (713) 645-0167; CA (714) 978-8066, (415) 574-8155

World Headquarters: Nærum, Denmark. Sales and service in principal US cities and 55 countries around the world